

Tapered SwissPlus[®] Implant Technique Manual

Surgical and Restorative Procedures



ZIMMER BIOMET
Your progress. Our promise.

Table of Contents

Overview	4
Indications for Use	4
Patient Evaluation and Selection	5
Preoperative Planning Considerations	6
Implant Design and Specifications	8
Guidelines for Implant Selection	12
Surgical Procedures	16
General Surgical Instructions	17
Surgical Kit with Dríva Drills (OPCST)	18
Drilling Sequence with Dríva Drills	19
Implant Site Preparation	20
Implant Placement	24
Soft and Dense Bone Implant Protocols	26
Restorative Procedures	27
Restorative Options	28
Abutment Flowchart	30
Selecting Abutments	33
Impression Transfer System	34
Indirect (Closed-Tray) Transfer Technique	34
Direct (Open-Tray) Transfer Technique	36
Immediate Impression Transfer Technique	37
Full-Contour Abutment System	38
Narrow Abutment System	47
“Cast-To” Gold Abutment System, Engaging	58
Tapered Abutment System	65
Ball Abutment System	75
Non-Engaging Abutment System	83
Accessories	88
Prosthetic Tools and Torque Wrenches	88

Overview

The Surgical and Restorative Procedures Manual is designed to provide an overview of the presurgical, surgical and prosthetic procedural considerations applicable to the Tapered SwissPlus Dental Implant System.

This manual is designed to serve as a reference guide for clinicians utilizing the Tapered SwissPlus Dental Implant System. The success of any dental implant system depends upon proper use of the components and instrumentation. This manual is not intended for use as a substitute for professional training and experience. The clinician should use medically sound treatment planning and procedures appropriate for each patient's individual case for predictable results.

The Tapered SwissPlus Implant is designed to be placed at tissue level with a one-stage surgical procedure. The fluted machined neck functions as the transmucosal extension of the implant receiving the prosthetic component of the restoration. The MTX microtextured titanium portion of the implant which includes the threaded area is placed subcrestal.

Indications for Use

The Tapered SwissPlus Implant System is designed for use in edentulous mandibles or maxillae for attachment of complete denture prostheses for immediate or conventional loading, or as a terminal or intermediary abutment for fixed or removable bridgework, or as a free standing single tooth replacement.

For additional information on Tapered SwissPlus Implants and Prosthetic Components, please reference the Instructions for Use for the individual product, available at <https://labeling.zimmerbiomet.com>.



Patient Evaluation and Selection

Team Approach

Successful implant treatment requires the coordinated efforts of several dental professionals – the restorative dentist, the surgeon (prosthodontist, periodontist, oral surgeon or general dentist), the laboratory technician and the dental hygienist. By holding a presurgical conference, these individuals are able to develop an appropriate treatment strategy. This provides a balance between esthetic, functional and surgical goals. In addition, the coordinated approach ensures that treatment is complete, guarding against omission of important technical considerations such as the use of a surgical guide for implant positioning, and the biomechanical boundaries of the final prosthesis.

Patient Evaluation and Selection

- Take a general medical history
- Undertake a psycho-social evaluation
- Explore indications and contraindications
- Determine anatomical landmark considerations related to implant positioning
- Determine feasible vertical dimensions
- Consider biomechanical requirements of final restoration
- Discuss treatment objectives and patient's expectations
- Perform various radiographic evaluations

Presurgical Planning Considerations

Proper stress distribution is essential to the long-term success of both the prosthesis and the implant. Overload is one of the key contributors to implant failure and is especially important in the cuspid and molar regions.

To minimize excessive loads, the following guidelines apply:

- Decrease occlusal forces transferred to the implant by reducing the occlusal table width of the prosthesis.
- Distribute occlusal forces optimally by maximizing the number of abutments used to support the prosthesis.
- Place implants of maximum length and diameter while maintaining esthetics and long term success of the restoration.
- Position and incline the implants to ensure good prosthetic design, function, and esthetics. Direct forces of occlusion along the long axis of the implant.
- Cantilevering should not be part of a treatment plan due to the force amplification of the resulting moment arm.
- Strengthen the overall treatment plan in patients with a heavy muscular profile or whose occlusal analysis indicates a strong bite by using the largest size implants, maximum numbers of implants and abutments, minimizing the use of cantilevers, and placing abutments for the most even distribution of occlusal loads.
- Design of the proposed restoration should also take into consideration the opposing dentition.

Diagnostic and Surgical Guides

Implant dentistry is guided by the restorative aspect of the procedure therefore it is a prerequisite to evaluate the position of the surrounding anatomical landmarks and natural teeth relative to the proposed area for implant placement.

Rule of "P" – Proper Pretreatment Planning Prevents Prosthetic Problems

Fabricate diagnostic casts with a wax-up of the proposed position of the teeth in the implant prosthesis. The Implant Team will utilize the diagnostic casts to fabricate the following if required:

- Guide with included markers for a variety of radiological exams - Panoramic, periapical, Computerized Tomography (CT scan), etc.
These exams can supply the team with information regarding bone quality and quantity, location of vital structures (mental nerve canal, sinus cavities, labial or lingual bone contour, and surrounding roots if present), and soft tissue height relative to the occlusal plane.
- Surgical drill guide to be utilized at time of surgery for implant osteotomy preparation, taking into consideration mesio-distal, bucco-lingual angulation and placement of the implants while maintaining required distance between the implants.
- Occasionally the surgical guide can be resterilized and used by the restoring clinician for planning the contours of the final prosthesis. The guide may also be used in the decision-making process for abutment selection and preparation and/or making the final implant or abutment impressions.

Preoperative Planning Considerations

Clinical Assessment

Preoperative Planning Considerations:

Proper treatment planning, as well as the selection of the proper implant length and diameter, are crucial to the long-term success of the implant and restoration.

Before an implant can be selected, the anatomical foundation available to receive the implant must be carefully assessed. Several steps should be taken to complete the evaluation:

1. Clinical examination of the oral cavity can provide important information about the health of the soft tissue at the proposed implant site. Tissue tone and the state of the superficial tissues should be evaluated. In addition, the patient should demonstrate an adequate dimension of attached gingiva or keratinized tissue at the site selected for implantation. In partially edentulous cases, the periodontal status of the remaining dentition should be assessed and interaction between the implant restoration and the adjacent natural dentition should be considered.
2. The bony foundation and ridge need to be clinically analyzed to ensure the presence of proper dimensions and the amount of bone for implant placement. At least one millimeter of bone should be present at the buccal and lingual aspects of the implant following placement. During the planning stage, it is useful to measure the existing bone foundation.

NOTE: Please ensure as many implants as necessary are used for a fully stable restoration.

CT Scans:

Image-guided surgical planning allows surgeons to see anatomical landmarks such as nerves, sinus cavities and bony structures in order to plan for the placement of dental implants and prostheses.

Through the use of CT scans, clinicians are able to more precisely measure the locations of anatomical structures, dimensions of the underlying bone and ascertain bone densities in order to plan and treat clinically demanding cases.

Radiographic Transparencies:

A dental implant radiographic transparency supports the preoperative implant treatment planning process. A radiographic transparency is overlaid onto a radiograph to assist the clinician

in the preoperative determination of options for implant length and diameter. The vertical height of the bone can be determined radiographically. Accurate measurement of the vertical dimension on the radiograph facilitates the selection of the appropriate implant length. This helps to avoid implant placement into the maxillary sinus, the floor of the nose or the mandibular canal, and prevents perforation of the inferior aspect of the mandible. Measurements can be made directly on the panoramic radiograph using a millimeter ruler. Corrections should be made for the degree of enlargement or reduction produced by the particular radiographic equipment.

Radiographic marking balls of a known dimension can be embedded in a plastic template prior to radiographic examination. Once the radiograph is taken and the metal marking balls are visible on the image, measurements can be taken to determine the amount of bone available for implant placement.

To calculate the distortion factor, a simple formula can be utilized: $(5 \div A) \times B =$ the amount of actual bone available.

Formula Key

- Radiographic marking ball = 5.0 mm in diameter
- A = Size of marking ball image on radiograph
- B = Length in millimeters on the radiograph of available bone between the crest of the ridge and the inferior alveolar canal

Example:

$$A = 6.5 \text{ mm}$$

$$B = 14 \text{ mm}$$

Therefore: $(5 \div 6.5) \times 14 = 10.76 \text{ mm}$ actual bone available

NOTE: A 2.0 mm margin of safety, from the apical end of the implant to any adjacent vital structure, should be considered.

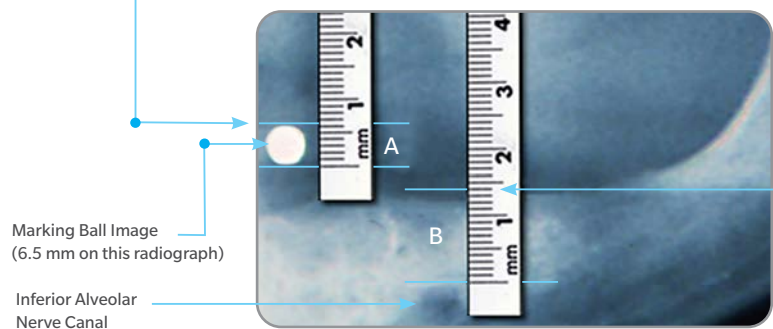

Radiographic Transparencies Instructional Steps:

A dental implant radiographic transparency supports the preoperative implant treatment planning process. A radiographic transparency is overlaid onto a radiograph to assist the clinician in the preoperative determination of options for implant length and diameter. It is used in conjunction with a 5 mm radiographic marking ball. Representations of the implant and the 5 mm radiographic marking ball are shown on the radiographic transparency at 100%, 115%, and 125% scales.

Visually inspect the transparency before each use for damage. The transparency should not be used if damaged or deteriorated. The following steps outline the proper use of the radiographic transparency in conjunction with the 5 mm radiographic marking ball(s) during preoperative planning:

1. Overlay the 100%, 115%, and 125% scaled 5 mm circular radiograph ball outline found on the transparency over the 5 mm radiographic ball image on the radiograph and determine which outline is closest to the diameter of the radiographic ball image on the radiograph. If the radiographic ball image on the radiograph extends outside the circular border of the radiographic ball outline on the 100% scale, use either the 115% or 125% scale for measurement estimations. If the radiographic ball image extends outside the circular border of the radiographic ball outline on the 125% scale, DO NOT use this radiographic transparency and refer to the Radiographic Marking Balls procedure to determine approximate bone height (See section on calculation of distortion factor on page 6).

NOTE: The radiographic ball should maintain its spherical shape on the radiograph, otherwise distortion that cannot be measured may have occurred. If this happens, it is recommended that a new radiograph be taken.

2. Select the scale (100%, 115%, or 125%) to use based on which circular radiograph ball outline best matches the diameter of the radiographic ball image on the radiograph.
3. To determine an approximation of available vertical bone height at the proposed implant site, align the zero mark on the selected ruler (100%, 115%, or 125%) to the crest of the edentulous ridge and measure the length between the crest and anatomical structures in the proposed implant site including the floor of the maxillary sinus, the floor of the nose and the mandibular canal.

NOTE: A minimum of 2 mm margin of safety, from the apical end of the implant to the adjacent vital structure, should be considered.

4. Overlay the implant silhouette corresponding to the selected scale (100%, 115%, or 125%) onto the proposed implant site to visually estimate if adequate vertical bone height is present for the selected implant length.

NOTE: The intended use of this device is exclusively for preoperative planning and to be used as a guide. Implant length and diameter should not be determined solely by relying on the radiographic transparency.

Implant Design and Specifications

Implant Properties and Dimensions

Implant Diameter:

This is the dimension taken from the peak of the widest thread to the same point on the other side of the implant, referred to as the outside dimension of the thread. In the Tapered SwissPlus system we have two distinct implant designs with different thread dimensions:

- Tapered SwissPlus Implants are available in two body diameters, 3.7 mmD and 4.8 mmD.

The tapered implants taper along the full length of the implant originating at the coronal first thread. The degree of taper on the tapered implants varies depending on their length to ensure that the apical diameter is consistent with all 4 lengths of implant, the shorter the implant the greater the degree of taper.

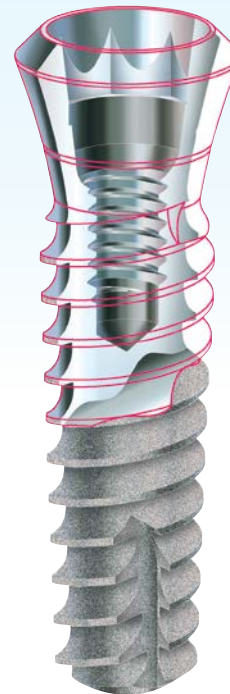

Tapered SwissPlus Implants

3.8 mmD Platform with a 2.5 mmD Internal Hex

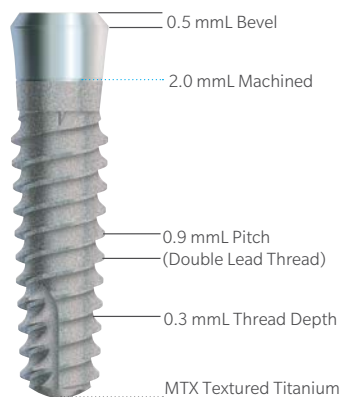

3.7 mmD Tapered SwissPlus
3.0 mmD Apex Diameter

4.8 mmD Platform with a 3.0 mmD Internal Octagon

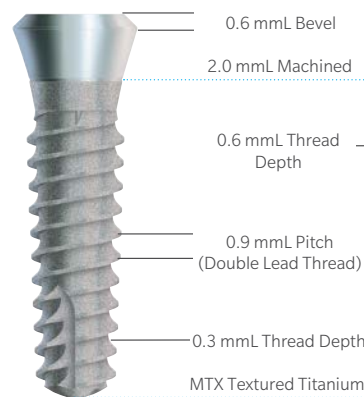

3.7 mmD Tapered SwissPlus
3.0 mmD Apex Diameter

4.8 mmD Platform with a 3.0 mmD Internal Octagon

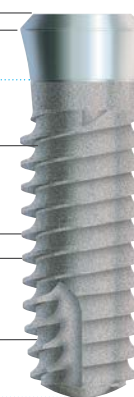

4.8 mmD Tapered SwissPlus
3.8 mmD Apex Diameter

Implant Platform:

The diameter is measured at the height of contour (widest point above the undercut of the fluted neck) of the implant top.

The Tapered SwissPlus system has two types of implant platform diameters and designs:

- 4.8 mmD platform - (Fig. 1a and b). A 45° external beveled shoulder tapers up from the height of contour of the implant to the coronal area, which has a 3.5 mmD opening. The height of this bevel is approximately 0.6 mm above the height of contour. From the edge of the opening, a 8° tapered internal beveled wall leads into a 3.0 mmD flat-to-flat octagon which is 1.5 mm deep. Below the octagon is a continuation of the 8° bevel which leads into the threaded area where the fixation screw is received.
- 3.8 mmD platform - (Fig. 2a and b). A 40° external beveled shoulder tapers up from the height of contour of the implant to the coronal area, which has a 2.85 mmD opening. The height of this bevel is approximately 0.5 mmL above the height of contour. From the edge of the opening, a 15° tapered internal beveled wall leads into a 2.5 mmD flat-to-flat hexagon which is 1.85 mm deep. Below the hexagon is the threaded area where the fixation screw is received.

NOTE: The fixation screws used in these two internal implant configurations are **NOT** cross compatible.

4.8 mmD Platform

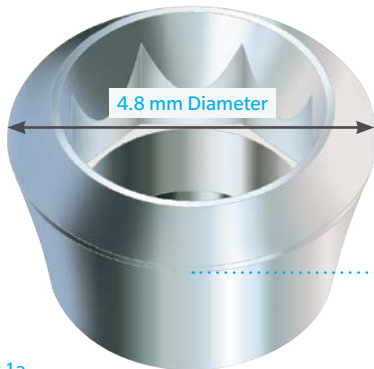

Fig. 1a

3.8 mmD Platform

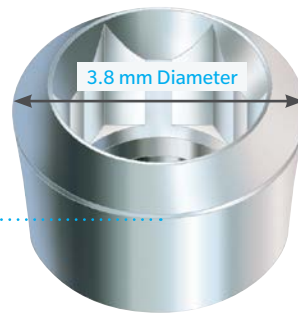

Fig. 2a

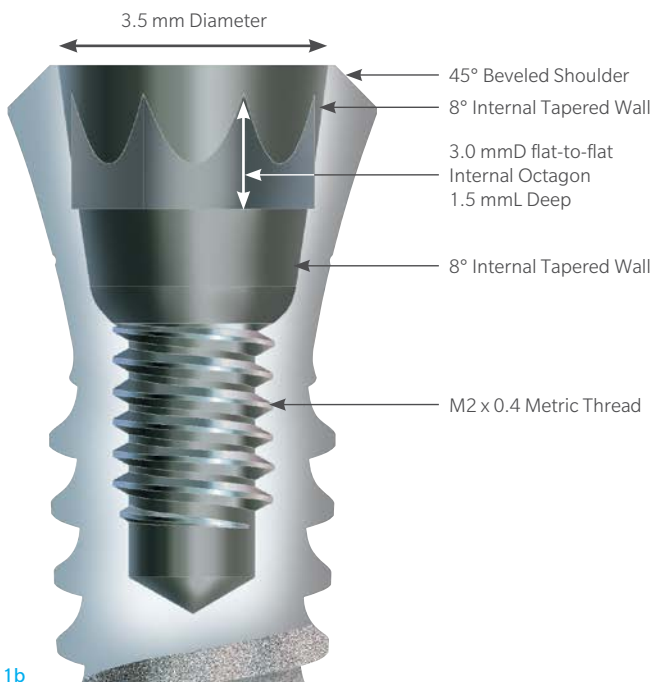

Fig. 1b

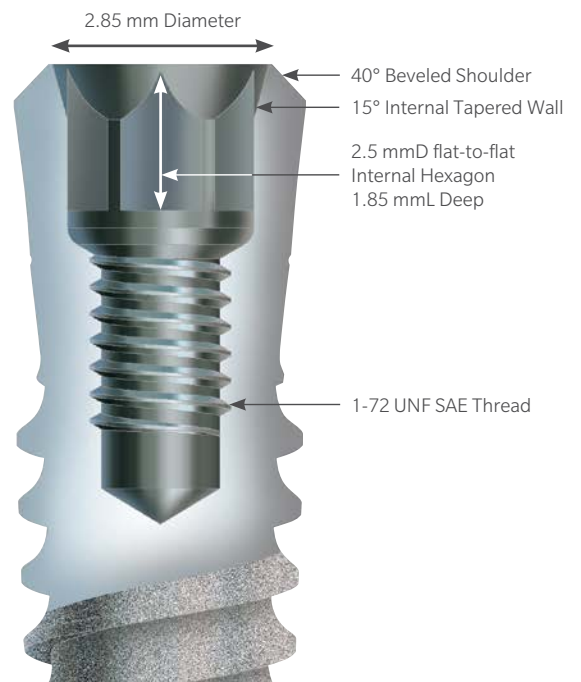
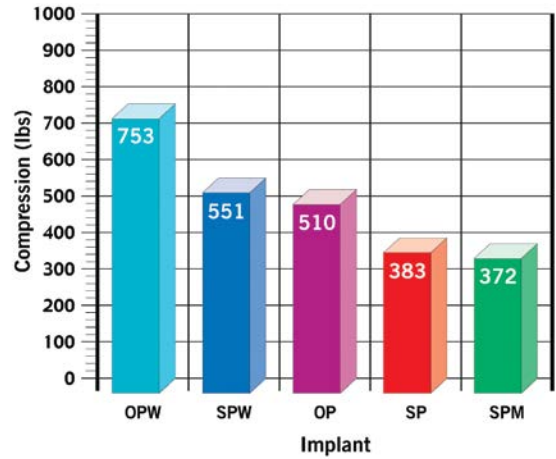
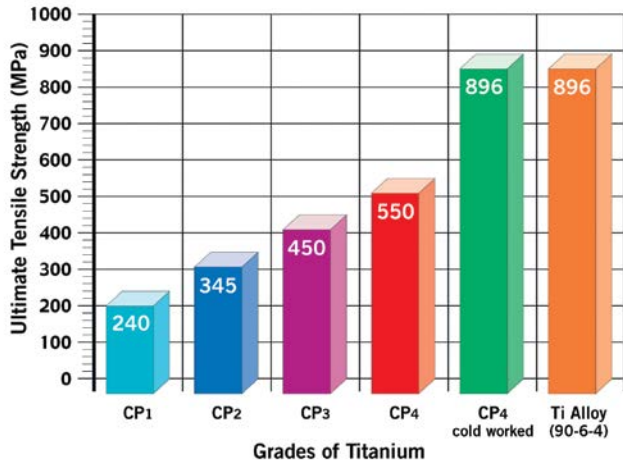

Fig. 2b

Implant Material:

Cold worked Grade 4 commercially pure titanium has an Ultimate Tensile Strength of 130 ksi (896 MPa), withstands 23 in-lbs (260 Ncm) of torque and withstands between 372-753 lbs (1655N-3350N) of compression at 30°.

(Data on file)



Implant Surface:

(MTX[®]) Medium-rough surface created by blasting the surface with HA particulate. The blasting and cleaning process preserves thread sharpness necessary for self-tapping. The machined area located above the blast line is 2.0 mmL for the tapered implants (to the height of contour), and is placed supra-crestal in standard placement procedures.

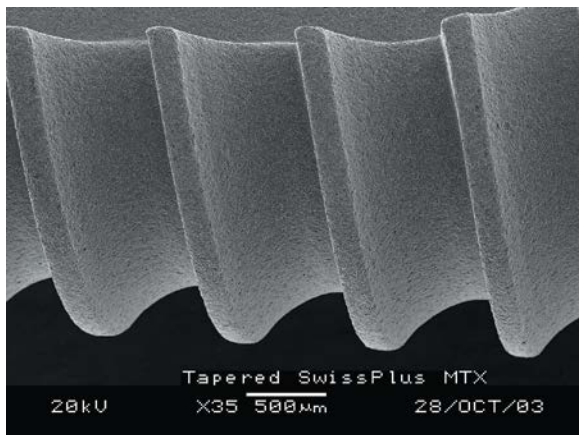

SEM of the buttress thread with MTX textured surface on the Tapered SwissPlus Implant. Texturing process maintains the thread sharpness.



Transition between machined collar and textured surface of Tapered SwissPlus Implant.

Implant Thread Design:

The Tapered SwissPlus external thread is based on a flat-based (buttress) thread.

- Tapered Swissplus Implants, 3.7 mmD and 4.8 mmD, have a double lead thread which adds 33% more thread than a single lead thread design. The two threads start 180 degrees offset from one another.
 - The 3.7 mmD tapered implant designs have a uniform 0.3 mmD thread depth with a 1.8 mmD thread pitch (0.9 mmD peak-to-peak due to the double lead thread design).
 - The 4.8 mmD tapered implant begins with the apical threads having the standard 0.3 mmD thread depth but the depth increases to 0.6 mmL towards the top two threads of the implant. This results in an increase of thread surface area and an increase of 34% bone-to-implant contact at time of implant placement.

Double Lead Thread

Fig. 3a) Side view of both threads, colored red or blue.

Fig. 3b) Side view of implant with one thread colored to indicate the presence of two threads traversing the length of the threaded portion of the implant.

Fig. 3c) Apical end of the Tapered SwissPlus indicating the start of the two threads 180° from each other.



Fig. 3a

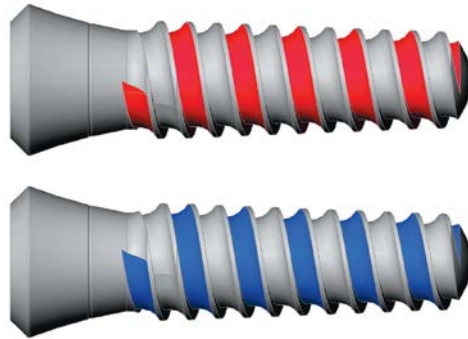

Fig. 3b

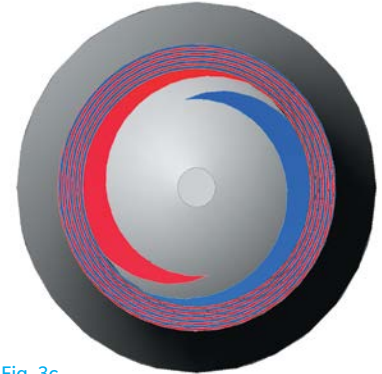

Fig. 3c

Guidelines for Implant Selection

Anatomical Requirements for Implant Selection and Placement

During the process of case diagnosis and treatment planning the question always arises: "What is the right implant for the proposed restoration?"

The design, quantity, diameter, and length of implants to be placed will depend on the following:

- Quality and quantity of available bone.
- Partially or fully edentulous restoration affects placement and spacing between implants (Fig. 4a).
- Fully or partially implant supported (determines quantity of implants).
- Cement- or screw-retained restoration (determines implant angulation as well a bucco-lingual placement).
- Mesial and/or distal boundaries.
 - a) Natural dentition requiring review of sub- and supra-crestal constraints:
 - Mesial and distal borders of surrounding coronal contours. Example: In Fig. 4b, the 3.8 mmD platform is preferable to the 4.8 mmD due to mesial distal constraints. At least 1 mm on either side of the platform diameter is minimum requirement for restorative contours.
 - Convergent or divergent roots. Tapered implants allow for larger diameter in same area (Fig. 4c).
 - b) Mental foramina. Vertical height above mandibular canal is often not sufficient distal to the foramen.
- Buccal and/or lingual boundaries.
 - a) Buccal and/or lingual restoration contours. Minimum requirement for restorative contours is 1 mm on either side of the platform diameter.
 - b) Restorations require space for substructures and substantial veneering materials (i.e., denture).
 - c) Buccal and/or lingual osseous depressions require the use of narrow or tapered implants (Fig. 4d).
 - d) Width of the crestal bone requires the use of implants that have a neck diameter which allows for a minimum of 1-1.5 mmD of bone on buccal and lingual borders (Fig. 4e).
 - e) Available bone to allow placement such that the occlusal force is axial through the center of the implant body.

Minimum Space between Implants

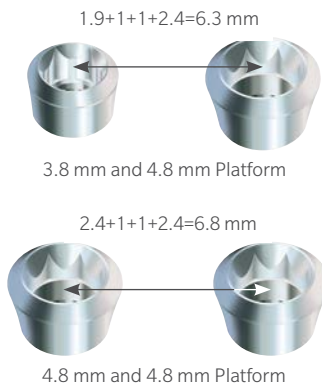

Fig. 4a

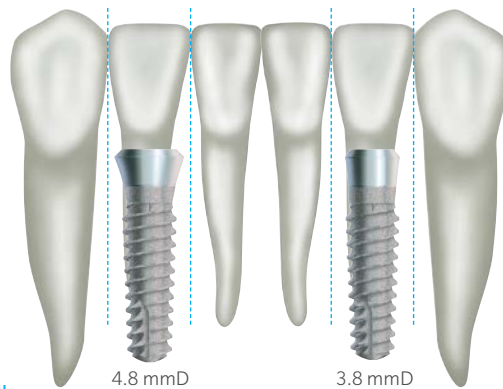

Fig. 4b



Fig. 4c



Fig. 4d

- Anatomical vertical limitations.
 - a) Allow spacing of 1-2 mm above the mandibular canal (Fig. 4f).
 - b) Allow spacing below the floor of the sinus cavity unless sinus grafting procedures are planned.
 - c) Correct the plane of occlusion of opposing dentition to eliminate the restriction often created by over eruption of unopposed dentition. This will allow for sufficient space for the final restoration.
 - d) If free-standing retentive anchors are proposed for the restoration, implants greater than 10 mm are required, as well as sufficient ridge height to prevent excessive lateral load being applied to the implant (see section on Ball Abutments).
 - e) Placement of the restorative platform relative to the type of restoration being performed: sub-gingival for esthetic restorations (Fig. 4g) and supra-gingival for non-esthetic restorations (Fig. 4h) will ultimately determine the length of implant to be placed.
 - f) Maintain an acceptable crown to implant ratio, preferably 1:1.
- Anatomical dimensions of the tooth or teeth being replaced. The surface area of the implant that is sub-crestal should approximate as close as possible the surface area of the tooth being replaced.

Charts of teeth and implants are on following pages.

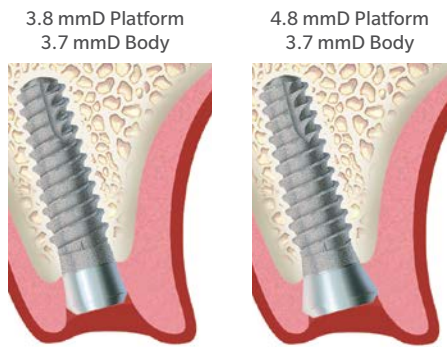

Both implants have the same width but different mesial distal bone requirements

Fig. 4e



Fig. 4f

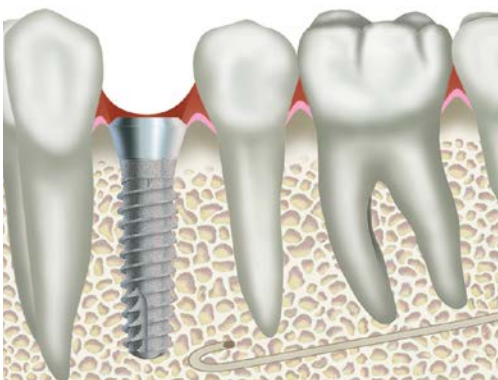

Fig. 4g

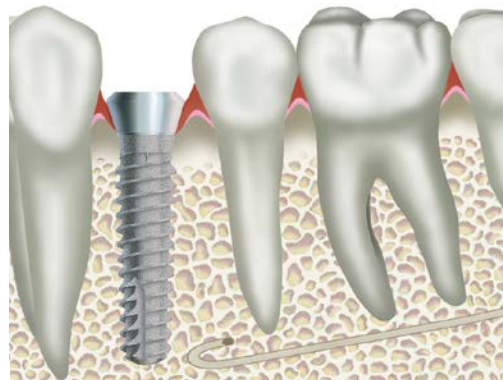















Fig. 4h

Tooth Root Surface Area



Per Ante's Law, "The total periodontal membrane area of the abutment teeth should equal or exceed that of the teeth to be replaced." The following tables provide the average surface areas of natural teeth and of Tapered SwissPlus dental implants.

Tooth	Maxillary		Mandibular	
	Surface Area (mm ²)	Ranking	Surface Area (mm ²)	Ranking
Central	 204	6	 154	7
Lateral	 179	7	 168	6
Canine	 273	3	 268	3
First premolar	 234	4	 180	5
Second premolar	 220	5	 207	4
First molar	 433	1	 431	1
Second molar	 431	2	 421	2

¹ Root surface measurement and a method for x-ray determination of root surface area. Jepsen, A., Acta Odont Scand, 21:35-46, 1963.

Implant Surface Dimensions

The surface area of the implants are measured from the level of surface texture to the apex of the implant. When the machined section is placed sub-crestal the surface area in contact with bone contact will increase.

Tapered SwissPlus Implant Body Surface Area		
Implant Type	Implant Length (mmL)	Textured Surface Area (mm2)
Tapered SwissPlus 3.8 Platform Diameter 3.7 Implant Diameter 	8	110
	10	138
	12	167
	14	194
Tapered SwissPlus 4.8 Platform Diameter 3.7 Implant Diameter 	8	110
	10	138
	12	167
	14	194
Tapered SwissPlus 4.8 Platform Diameter 4.8 Implant Diameter 	8	166
	10	215
	12	266
	14	310

Surgical Procedures



**Tapered SwissPlus
Implant System**

General Surgical Instructions

Cleaning and Sterilization Guidelines

For detailed cleaning and sterilization instructions, please refer to the Instructions for Use (IFU) for each product, available at <https://labeling.zimmerbiomet.com>.

Surgical instruments are reusable up to 15 uses, excluding those labeled as single use. Surgical instruments are susceptible to damage and wear and should be inspected before use. The number of uses per drill will vary and depends on a variety of factors including bone density encountered, proper handling and cleaning. Over time, repeat sterilizations may affect cutting efficiency and color appearance. Cutting edges should present a continuous edge and appear sharp. Check the latch-lock shank for wear to ensure the connection is not damaged. If inspection reveals signs of wear, damage, or unrecognizable color identification, replace the drill accordingly.

Surgical Kit with Original Driva Drills

Surgical Kit Layout

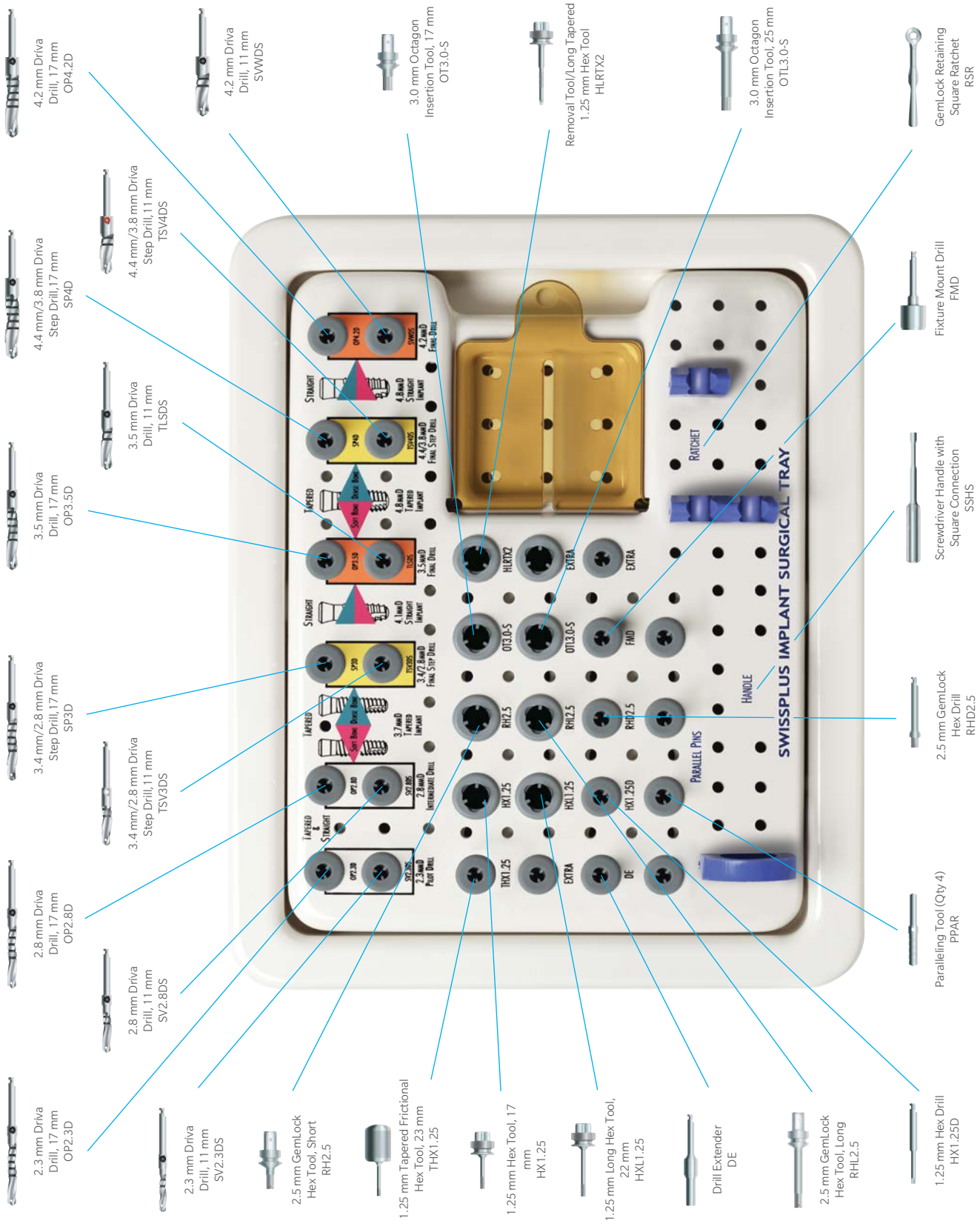

SwissPlus Drilling Sequence with Original Driva Drills

Tapered SwissPlus Drilling Sequence

3.7 mmD Tapered SwissPlus (3.8 mmD Platform and 4.8 mmD Platform)

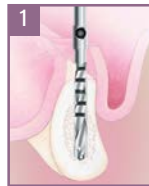

1
OP2.3D/SV2.3DS
2.3 mmD
Pilot Drill

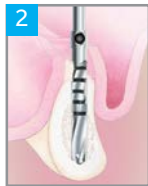

2
FOR SOFT BONE
OP2.8D/SV2.8DS
2.8 mmD
Final Drill for Soft
Bone Compression

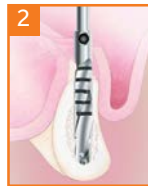

2
FOR DENSE BONE
SP3D/TSV3DS
3.4/2.8 mmD
Final Drill for
Dense Bone



3
**OPTIONAL FOR
DENSE BONE**
DT3.7
Cortical Bone Tap

4.8 mmD Tapered SwissPlus (4.8 mmD Platform)

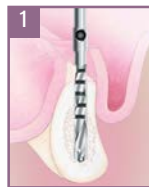

1
OP2.3D/SV2.3DS
2.3 mmD
Pilot Drill



2
SP3D/TSV3DS
3.4/2.8 mmD
Intermediate Drill

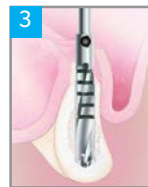

3
FOR SOFT BONE
OP3.5D/TLSDS
3.5 mmD
Final Drill for
Soft Bone with
4.8 mmD implants

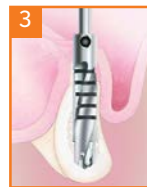

3
FOR DENSE BONE
SP4D/TSV4DS
4.4/3.8 mmD
Final Drill for
Dense Bone



4
**OPTIONAL FOR
DENSE BONE**
DT4.8
Cortical Bone Tap

Implant Site Preparation

Surgical Drilling Guidelines



Making the Initial Incision

Make a mesio-distal incision along the buccal side of the alveolar crest through the mucoperiosteum and attached gingiva to the bone. Flap and incision designs may vary due to clinician preference. The incision should be long enough to permit adequate reflection and a broad field of view without tearing the tissue. Occasionally, vertical releasing incisions may be employed.

Using a periosteal elevator, carefully lift the periosteum to expose the alveolar bone only as necessary to provide an adequate surgical working area.

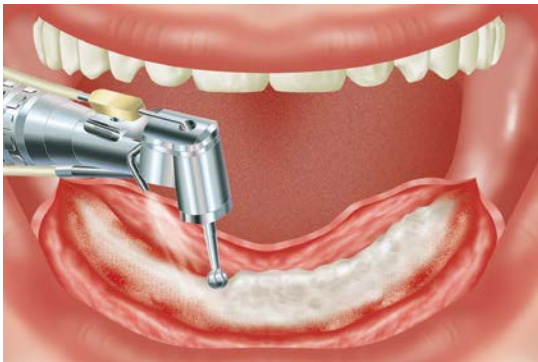

Removing Bone Irregularities

Place retractors or sutures to hold the soft tissues.

Remove any spinous ridges or other bone irregularities using the round bur or a Rongeur Forceps to create as flat a bone plateau as possible.

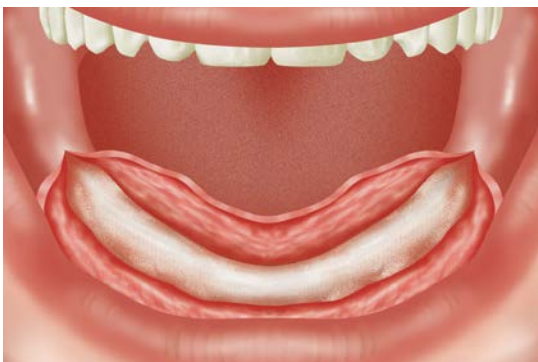

Assessing Implant Site

Keep bone removal to a minimum. Insufficient bone height/width and abnormal defects or contours not previously detected may now contraindicate placement of the implant.

Maintain previously discussed requirements for ridge width and implant requirements.

Ridge contour should be adequately palpated to estimate an angle of insertion which will achieve parallelism with other implants and natural tooth abutments where indicated.



Using the Drill Extension

Use the drill extension when additional length is required due to interference caused by adjacent teeth. The drill extension is available and extends the effective access of the cutting blade of the drill.

The drill extension has a standard latch-lock shank with a cylindrical shaft to accommodate the latch-lock type drill into the extension.

Do not use with drills other than the standard latch-lock type or exceed speeds of 850 rpm with the drill extension.

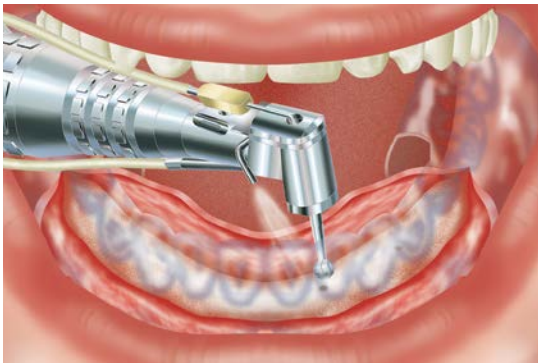

Marking the Implant Site

Seat the surgical guide in place to assist in marking the implant sites.

The guide can be kept in place during the first stages of the drill sequence to help with the inclination as well as spacing of the implant sites relative to the proposed restoration.

Use copious external irrigation with the Round (Rosette) Bur [1203] and create a dimple through the dense ridge crest in the area of each proposed implant site. The dimple helps to prevent the surgical drills from drifting (chatter) from the proposed drill site.

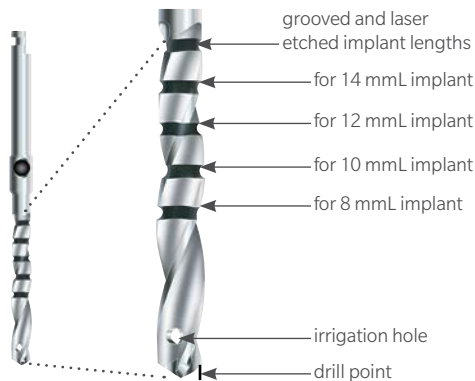

Using the Surgical Drills

Designed to be used with both internal and external irrigation with a surgical unit that can supply a range of drilling speeds from 15-2000 rpm with sufficient torque. A recommended range for drilling is between 600-850 rpm although clinicians may vary from this range in their protocol.

NOTE: The top of the laser/score line markings (0.5 mm in height) on the drills are in excess of the length of implant to be placed by 1.25 mm (8 mmL is actually 9.25 mmL). This added length is to accommodate for the design of the drill point. The 2.3 mmD Pilot Drill is the only drill that is close to the actual length (i.e. 8 mmL is actually 8.25 mmL).



Drilling the Osteotomy

Perform all drill procedures with a straight up-and-down motion in order to avoid creation of an oval-shaped osteotomy. This pumping action in combination with copious irrigation will also help to minimize excessive heat generation and preserve the vitality of bone. The system should deliver an adequate flow of irrigation (40-100ml/min.) for a cooling, low-trauma surgical procedure. Ensure that compressed coolant air is not introduced into the surgical site via a surgical bur.

Use the 2.3 mmD Drill [OP2.3D, SV2.3DS] to create a pilot hole to the depth of the implant to be used.

Flush the hole to remove all debris.

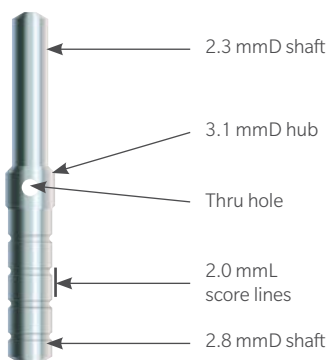

Using the Paralleling Pin

The pin is designed with opposing ends having two diameters, 2.3 mm and 2.8 mm. This enables the clinician to use the pins in the first two steps of the drilling sequence to ensure correct placement and alignment of the implants.

Larger diameter drills should follow the path created by the 2.3 and 2.8 mmD drills.

The 2 mmL score lines on the 2.8 mmD side of the paralleling pin can supply the clinician with an indication of height available for the restorative aspect of the procedure.

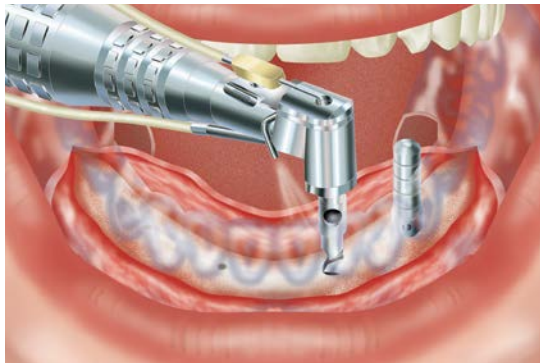

Inserting the Paralleling Pin

Thread floss through the hole in the middle of the pin for retention to prevent patient aspiration.

Insert the smooth side of Paralleling Pin [PPAR] into the first 2.3 mmD osteotomy and confirm placement and alignment relative to the surgical guide.

Use the first pin as a guide and continue to drill the required sites to 2.3 mm diameter, inserting pins in each of the holes after they have been drilled then flushed to remove the debris.

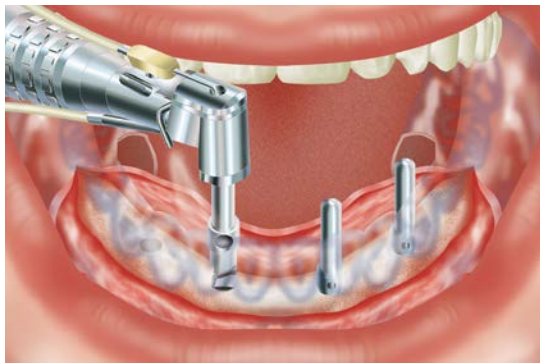

Drilling the Intermediate Osteotomy

Use the 2.8 mmD Drill [OP2.8D, SV2.8DS] to create an intermediate hole to the depth of the implant to be used.

When placing SPMB or SPB series of implants in soft bone, the 2.8 mmD drill can be used as the final drill size.

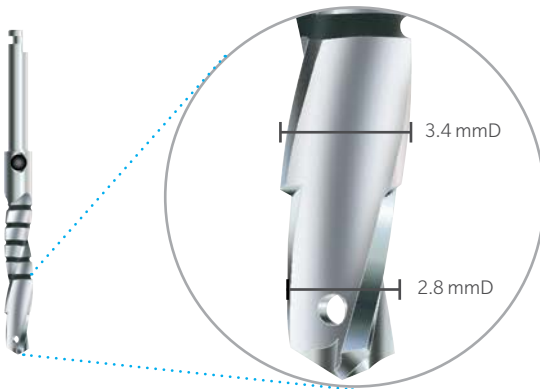

Using Stepped Drills for Tapered Implants

Use stepped drills for final sizing of the osteotomy when placing tapered implants (SPMB, SPB and SPWB series) in dense bone. These drills are designed to accommodate the varying lengths of tapered implants without having to have length specific tapered drills. The drill has two diameters of straight walled design incorporated into one drill. This allows the implants to obtain maximum engagement into bone no matter the length of implant being used. The length of the stepped area is approximately 4 mm from the point of the drill to the start of the wider portion.

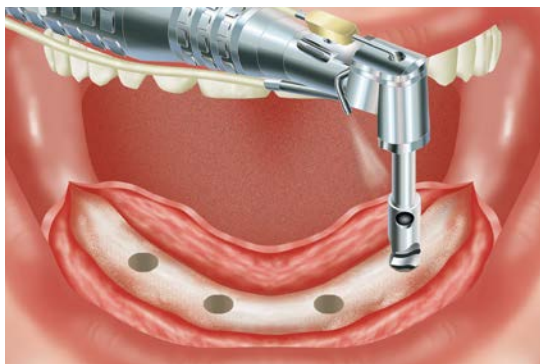

Final Sizing of Osteotomy

Use the final drill [SP3D, TSV3DS] which has a 3.4 mm/2.8 mmD step for the 3.7 mmD tapered implants and the final drill [SP4D, TSV4DS] which has a 4.4 mm/3.8 mmD step for the 4.8 mmD tapered implants. The OP3G or TSV34D28SG can be used directly after the 2.3mmD Drill without using the 2.8 mmD intermediate.

NOTE: For internally irrigated drills, clean drill heads often to remove debris and ensure a sharp cutting surface. A 25-gauge needle can be used to clean the drill's irrigation hole, a 30-gauge is required for drills 2.8 mmD or narrower. Due to the density of bone commonly found in the symphysis region, use newer drills.

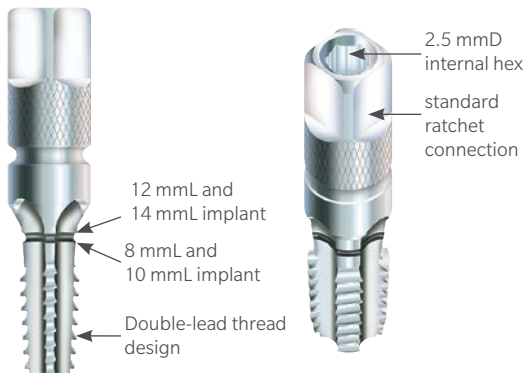

Cortical Bone Taps

Available for the double-lead Tapered SwissPlus Implants in diameters, 3.7 mm [DT3.7] and 4.8 mm [DT4.8]. For placement of implants in dense cortical bone, the tool is designed with a thread having the same configuration as the implant. Above the threaded area the tool flares out slightly to open the cortical plate to receive the wider neck of the Tapered SwissPlus Implants.

Use the bottom of the laser mark score line for placement of the 8 mL and 10 mL implants and the top of this line for placement of the 12 mL and 14 mL implants. This variance in height accommodates for the variance in tapers of the different lengths of implants as mentioned in the previous section.

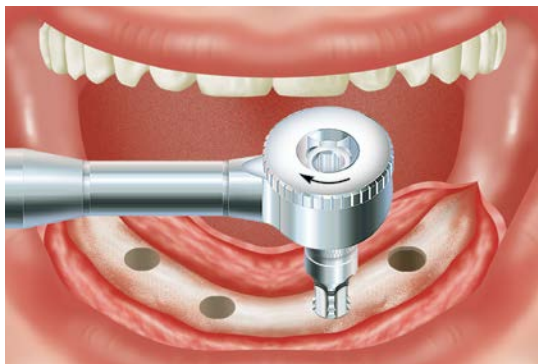

Contouring the Surgical Site

Use the Cortical Bone Tap in conjunction with the ratchet and rotate into the osteotomy.

In areas where there is limited space between the surrounding dentition a 2.5 mmD Hex Tool [RH2.5, RHL2.5] can be inserted into the back end of the Bone Contouring Tool to increase the vertical height of the tool allowing attachment of the ratchet. A 2.5 mmD Hex Drill [RHD2.5] can also be inserted into the recess to facilitate use with a high torque, low speed (15 rpm) surgical handpiece and motor.

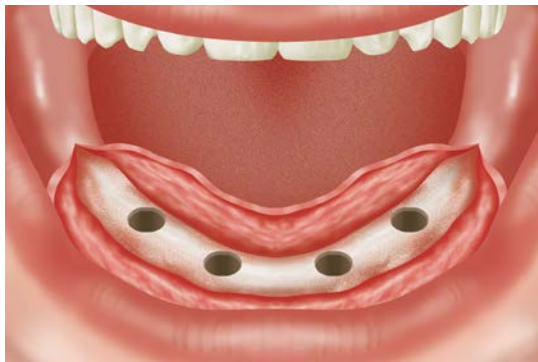

Preparing for Implant Placement

Irrigate the implant sites with sterile water and then suction prior to implant placement to ensure that no debris is left at the base or attached to the vertical walls of the osteotomy.

Any debris could hinder the vertical placement as well as possibly increase the insertion torque above acceptable limits.

Implant Placement

Inserting the Implant

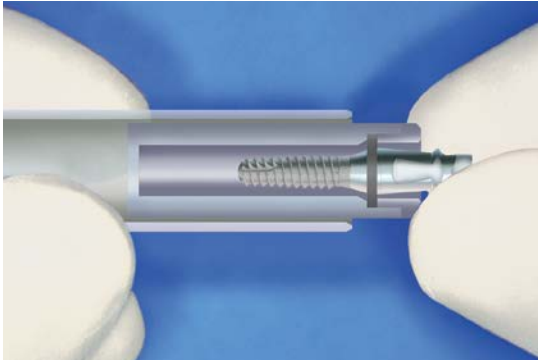

Removing the Implant

Remove the lid of the outer vial. Drop the inner vial and contents onto a sterile field. The implant is supplied preattached to a multi-functional Fixture Mount for easy delivery. Remove the implant assembly from the sterile, inner vial and carry it to the implant osteotomy with the 2.5 mmD Hex Drill [RHD2.5], Ratchet [RSR], Screw-driver Handle [SSHS] or fingers as shown.

NOTE: The supplied Surgical Cover Screw is located within the outer vial, so care should be taken when placing contents on the sterile field.

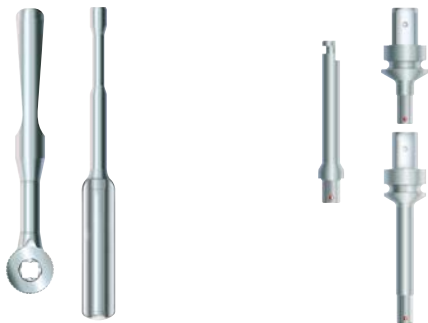

Tools that engage outside of fixture mount

Tools that engage inside of fixture mount

Tooling for Carrying the Implant

The implant may be driven manually or with the use of a surgical motor at speeds less than 50 rpm. Tools that can carry the implant are:

- 1) The Ratchet [RSR] attached to the fixture mount.
- 2) The Stainless Steel Handle [SSHS] attached to the fixture mount.
- 3) The 2.5 mmD GemLock Hex Drill [RHD] engages directly into the female hexagon of the implant fixture mount.
- 4) The 2.5 mmD GemLock Hex Tool [RH2.5, RHL2.5] engage directly into the female hexagon of the implant fixture mount.

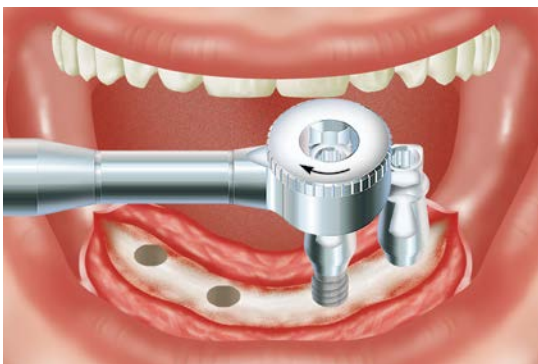

Inserting the Implant

Gently seat the implant into the osteotomy. The Tapered SwissPlus will insert almost a third of the way into the site due to the taper along the full length of the implant.

View placement series on following pages. Screw the implant into the prepared site using the ratchet [RSR].

Optional: In dense bone initiate insertion by method mentioned above, remove the fixture mount and then proceed to place the implant using the Insertion Tool [OT3.0-S, OTL.3.0-S for octagon platform and RH2.5, RHL2.5 for hexagon platform] in combination with the Ratchet [RSR].

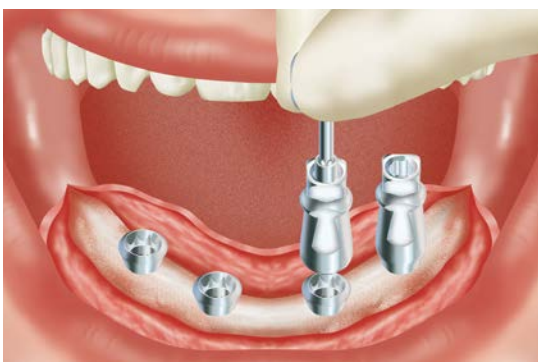

Removing the Fixture Mount

After the implant is seated at the desired level, use the 1.25 mmD GemLock Hex Tool [HXGR1.25] to unthread the fixture mount screw. If unable to unthread, seat the ratchet over the fixture mount and use it as a countertorque. Insert the 1.25 mmD Hex Tool through the ratchet and loosen the screw. Disengage the fixture mount and screw from the implant by gently pulling up in an axial direction.

Optional: If unable to remove the fixture mount from the implant, remove the screw completely. Thread the appropriate Removal Tool [HLRTX2 for octagon platform and TLRT2 for hexagon platform]. Continued clockwise rotation of the tool will disengage the fixture mount from the implant.

Attaching the Surgical Cover Screw

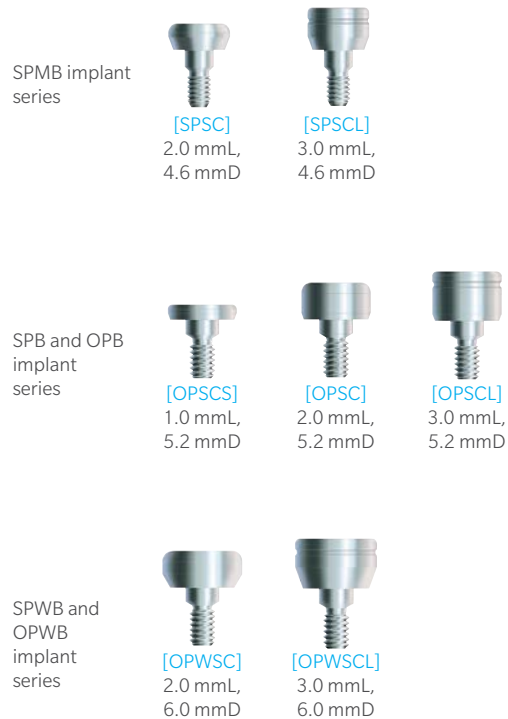

Selecting the Surgical Cover Screw

Implants are supplied with a Surgical Cover Screw (2 mmL) corresponding to the diameter of the fixture mount used to place the implant.

Optional Cover Screws are Available:

- For areas with thick soft tissue or subgingival placement of implants in esthetic areas, use 3 mmL cover screw. This cover screw has a suture groove at 2 mmL to assist in guiding soft tissue healing from time of implant placement.
- Areas with reduced vertical clearance use 1 mmL cover screw. For the wide diameter implants use the 1 mmL cover screw from the SPB and OPB implant series, [OPSCS].

All vertical measurements are taken from the height of contour of the implant to the top of the cover screw.

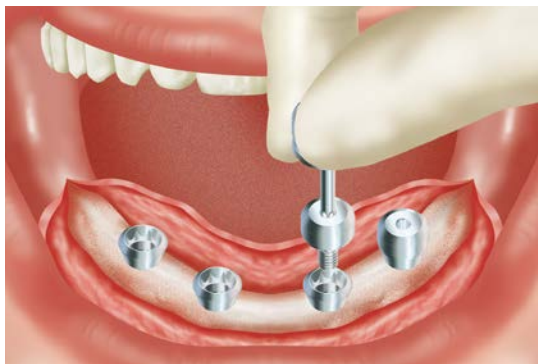

Placing the Surgical Cover Screw

Attach the appropriate Surgical Cover Screw to the implant using a 1.25 mmD Hex Tool and tighten using finger pressure only.

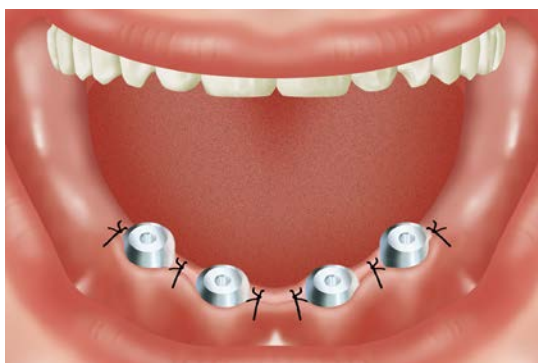

Suturing the Soft Tissue

Using suture material of choice, close the soft tissue around the Surgical Cover Screws leaving them exposed during the one-stage healing period.

Seat the provisional restoration in place ensuring that the prosthesis is appropriately relieved to prevent any premature loading on the exposed implants.

Soft- and Dense- Bone Implant Protocols

Tapered Implant Placement



Final Sizing of Osteotomy

Drill the osteotomy according to the density of the bone surrounding the proposed implant site.

In areas where the bone is commonly referred to as soft bone, it is often advocated to stop the drilling sequence at the straight drill before the final step drill.

Soft bone protocol: 2.8 mmD straight drill for 3.7 mmD implants and 3.8 mmD straight drill for 4.8 mmD implants.

Dense bone protocol: 3.4/2.8 mmD stepped drill for 3.7 mmD implants and 4.4/3.8 mmD stepped drill for 4.8 mmD implants.



Placing Implant into Osteotomy

Soft Bone Protocol: From time of initial placement of the implant in the straight hole, the implant will start to compress the bone. This occurs due to the fact that the hole size is slightly smaller than the apex size of the implant. **Example:** Using the 3.7 mmD implant having a 3.0 mmD apex and inserting into a hole with a 2.8 mmD opening.

Dense Bone Protocol: From time of initial placement of the implant in the stepped hole, the implant will drop almost a third of its length before stopping. This occurs because the hole size is bigger than the apex size of the implant. **Example:** Using the 3.7 mmD implant having a 3.0 mmD apex and inserting into a hole with a 3.4 mmD opening.



Placing Implant into Osteotomy, Close up

Soft Bone Protocol: Compression of bone occurring from time of initial insertion.

Dense bone protocol: Implant drops into hole almost a third of its thread length at time of initial insertion.

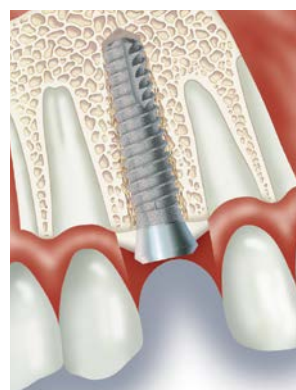

Completing Placement of Implant

Soft Bone Protocol: Compression of bone occurring the full length of the implant improving initial stability from time of placement.

Dense Bone Protocol: As the implant progresses, the thread will engage the walls of the osteotomy. When fully seated the 3.0 mmD apical end of the implant will engage the 2.8 mmD of the osteotomy.

The amount of engagement will increase over the length of the implant to the 3.7 mmD coronal threads engaging the 3.4 mmD section of the osteotomy. The inner dimension (3.4 mmD maximum) of the implant threaded area contacts the walls of the osteotomy but does not compress. (Measurements refer to 3.7 mmD implant sequence).



Tapered SwissPlus Implant System

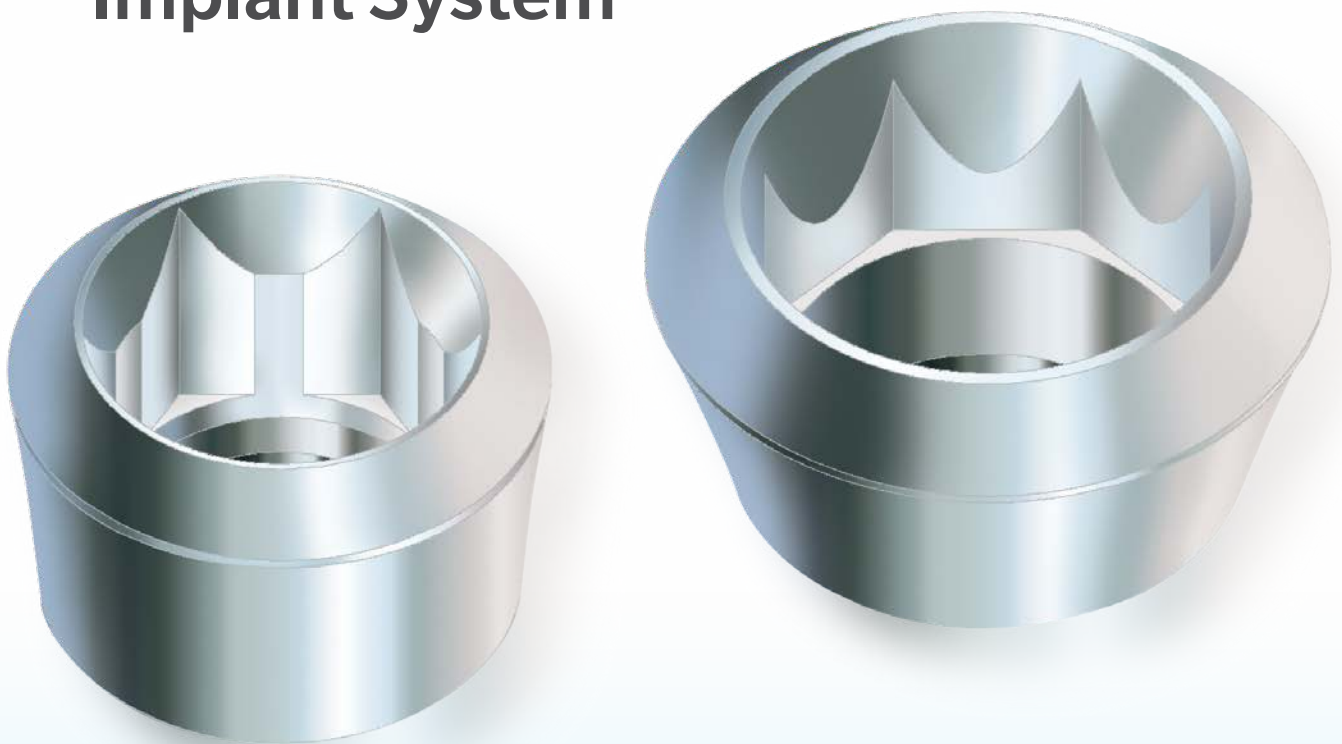

Restorative Options

Options for Partially Edentulous Restoration

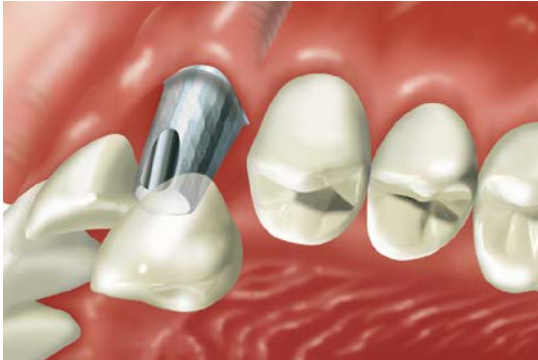

Abutment for Cemented Crown

Implant-Supported Prosthesis

- The prosthesis is removable only by the dentist.
- Interdigitates with the implant's octagon or hexagon for antirotational stability.
- Prosthetic design should reflect cosmetic and hygiene considerations.
- Provides restorative ease and flexibility with Full-Contour Straight or Angled and "Cast-To" Gold Abutment options.

NOTE: Available for 3.8 mmD and 4.8 mmD platforms

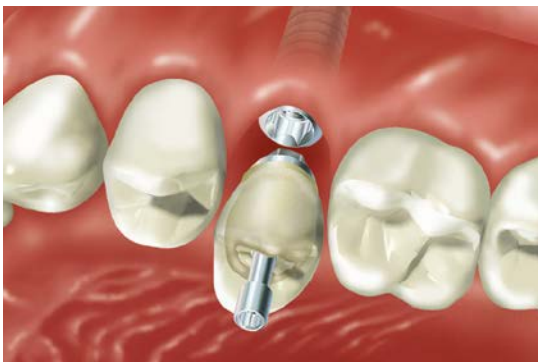

Abutment for Screw-retained Crown or Combined Post and Crown

Implant-Supported Prosthesis

- The prosthesis is removable only by the dentist.
- Interdigitates with the implant's octagon or hexagon for antirotational stability.
- Prosthetic design should reflect cosmetic and hygiene considerations.
- Provides options for screw-retained crown and combined post and crown.
- Abutment Type: "Cast-To" Gold Abutment.

NOTE: Available for 3.8 mmD and 4.8 mmD platforms



Abutment for Fixed Partial Dentures

Implant-Supported Prosthesis

- The prosthesis is removable only by the dentist.
- Interdigitates with the implant's octagon or hexagon for antirotational stability.
- Prosthetic design should reflect cosmetic and hygiene considerations.
- Provides restorative ease and flexibility with Full-Contour Straight or Angled and "Cast-To" Gold Abutment options.

NOTE: Available for 3.8 mmD and 4.8 mmD platforms



Abutment for Screw-Retained Fixed Partial Denture

Implant-Supported Prosthesis

- The prosthesis is removable only by the dentist.
- Prosthetic design should reflect cosmetic and hygiene considerations.
- **Abutment Types:** Tapered Abutment, Non-Engaging Abutment.

NOTE: Available for 4.8 mmD platform only

Options for Fully Edentulous Restorations

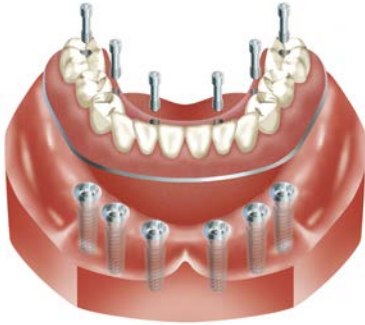

Screw-retained Denture

Implant-Retained, Implant-Supported Prosthesis

- This prosthesis is recommended primarily for the mandible.
- The prosthesis is removable only by the dentist.
- The secure fit offers the psychological advantage of a fixed prosthesis.
- Five to six implants are often preferred for the mandibular prosthesis.
- Six to ten implants are preferred for the maxillary prosthesis.
- Prosthetic design should reflect cosmetic and hygiene considerations.
- **Abutment Types:** Tapered Abutment, Non-Engaging Abutment.

NOTE: Available for 4.8 mmD platform only



Bar Overdenture

Implant-Retained, Implant-Supported Prosthesis

- This prosthesis is recommended for the maxilla and mandible.
- The overdenture is removable by the patient to facilitate hygiene and eliminate stress on the implant/prosthetic system, when removed.
- The overdenture is stable and feels natural to the patient.
- Four to six implants are often preferred for the mandibular prosthesis.
- Six to ten implants are preferred for the maxillary prosthesis.
- Various attachments are used to affix the denture to the bar.
- **Abutment Types:** Tapered Abutment, Non-Engaging Abutment.

NOTE: Available for 4.8 mmD platform only



Ball Bar Overdenture

Implant-Retained, Tissue-Supported Prosthesis

- This prosthesis is recommended primarily for the mandible.
- The overdenture is removable by the patient to facilitate hygiene and eliminate stress on the implant/prosthetic system, when removed.
- Slight prosthetic movement, but is stable and feels natural to the patient.
- Four implants are preferred for the Ball Bar Overdenture.
- **Abutment Types:** Tapered Abutment, Non-Engaging Abutment.

NOTE: Available for 4.8 mmD platform only



Ball Abutment Overdenture

Implant-Retained, Tissue-Supported Prosthesis

- This prosthesis is recommended primarily for the mandible.
- The overdenture is removable by the patient to facilitate hygiene and eliminate stress on the implant/prosthetic system, when removed.
- Denture movement is necessary, due to the limited number of implants.
- Retained by ball components on two implants and Cap Attachments in the denture.
- Two implants are required for a Ball Abutment Overdenture.
- **Abutment Types:** Ball.

NOTE: Available for 4.8 mmD platform only

Impression Transfer, Cement-Retained Restorations

Impression-Taking

Indirect Transfer
(w/ screw for Closed Tray Impressions)

Ø 3.8 mm Platform
Ø 4.6 mm Flare

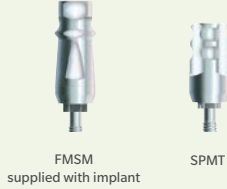

Ø 4.8 mm Platform
Ø 5.2 mm Flare

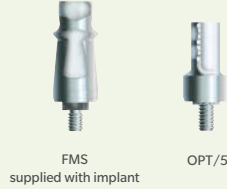

Ø 4.8 mm Platform
Ø 6.0 mm Flare

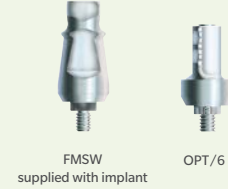

Direct Transfer
(optional procedure for Open Tray Impressions, Transfer supplied with Implant, screw sold separately)

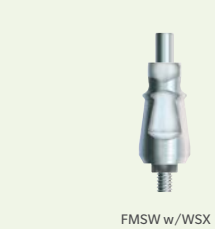
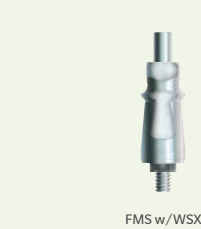

Implant Replica



Cement-Retained Restorations

Straight Abutment/Transfer
(w/screw)

Ø 3.8 mm Platform
Ø 4.6 mm Flare



Ø 4.8 mm Platform
Ø 5.2 mm Flare

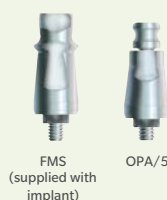

Ø 4.8 mm Implant Platform
Ø 6.0 mm Flare

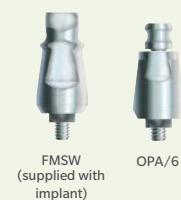

Narrow Straight Abutment
(w/transfer/waxing coping) and Replica
(sold separately)

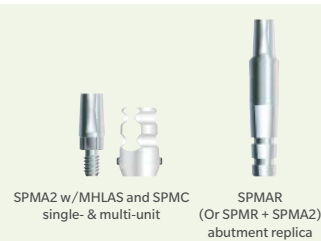

20° Angled Abutment for 6 positions
(w/screw)



Custom Restorations, Screw-Retained Restorations

Custom Restorations: "Cast-To" and Plastic Castable Abutments w/Screw

Single-Unit Restorations (Gold, Engaging)

Ø 3.8 mm Platform



SPGA w/MHLAS and OPS optimal, long waxing screw: MTWSD

Ø 4.8 mm Platform



OPGA w/GPCAS and OPS optional, long waxing screw: WSX

Multi-Unit Restorations (Gold, Non-Engaging)

N/A



OPGC w/GPCAS and OPS

Multi-Unit Restorations (Plastic, Non-Engaging)

N/A



OPCC w/GPCAS

Screw-Retained Restorations (for Ø 4.8 mm platform only)

Tapered Abutment Multi-Unit only (w/healing cap)

Ø 4.8 mm Platform



OPACT w/TATHC 1.6 mm



OPACT3 w/TATHC 3.0 mm

Tapered Abutment Components



ACTIT Tapered Abutment Indirect Transfer



ACTDT Tapered Abutment Direct Transfer



ACTR Tapered Abutment Replica Represents Tapered Abutment Attached to



Implant ACTGC Tapered Abutment Gold Coping w/Screw (SCTS) and Sheath (OPS)



ACTP 5.0 mm Plastic Castable Coping Includes Screw (SCTS)



TGC3 3.0 mm Tapered Abutment Bar Gold Copings w/Screw (SCTS)



TGC5 5.0 mm Tapered Abutment Bar Gold Copings w/Screw (SCTS)



TTC5 5.0 mm Tapered Abutment Titanium Bar Coping w/Screw (SCTS)



ACTT Titanium Temporary Coping Includes Screw (SCTS)

Overdenture Restorative Components

Overdenture Restorations

Locator® Abutment

Ø 3.8 mm Implant Platform



Ø 4.8 mm Implant Platform



Locator Components

Note: Replacement Males are available. See product catalog.



Overdenture Restorations

Ball Abutments w/ Cap Attachment

Ø 4.8 mm Implant Platform

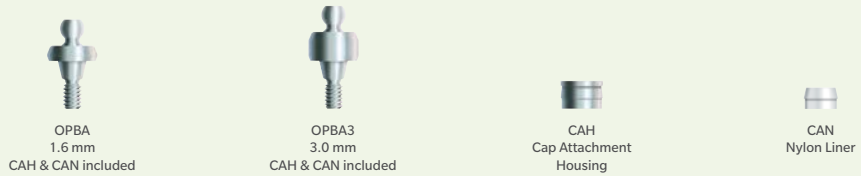

Ball Transfer Components



Selecting Abutments

3.8 mmD and 4.8 mmD Platform Tapered SwissPlus Implants

“Cement-to”, Screw-receiving and Overdenture Attachment Abutment Systems

The engaging abutments are assemblies that consist of a one-piece abutment body and an abutment screw. The base of the abutment body contains an external octagon or hexagon that interdigitates with the mating internal feature within the implant.

This engagement prevents rotation when the abutment screw is threaded into the implant. To complete seating the abutment screw must be tightened to 30 Ncm. These components are used for single-unit screw-retained [OPGA, SPGA] or single- and multi-unit cement-retained restorations [OPA2, SPMA2, OPH20, SPH20, OPA/5, OPA/6 or implant Fixture Mounts].

All non-engaging components [OPGC and OPCC] consist of a one-piece base with an abutment screw or an abutment body and screw machined in one-piece, commonly referred to as a one-piece abutment. Straight Narrow Abutments [OPA], Tapered Abutments [OPACT and OPACT3] and Ball Abutments [OPBA and OPBA3] do not engage the octagon of the implant and can only be used for multiple-unit splinted restorations or attachment overdentures.

NOTE: All these non-engaging components are available for the 4.8 mmD platform only.

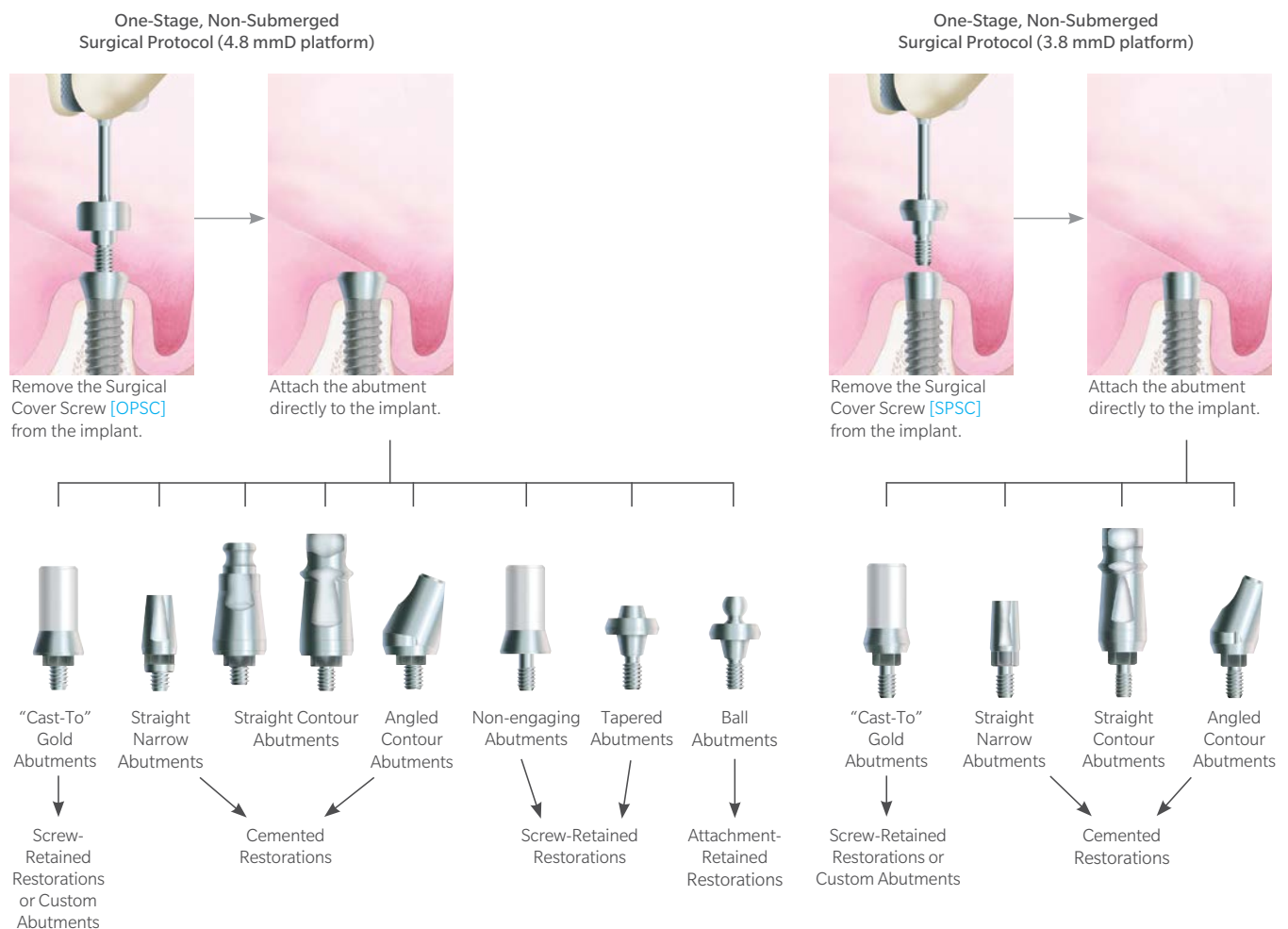

Impression Transfer System

Indirect (Closed-tray) Transfer Technique

Implant-level Indirect Transfers or Fixture Mounts for Closed-tray, Transfer Impression Technique

Designed to transfer the soft tissue profile as well as the implant's position and octagon or hexagon (SPMB series) orientation.

Indirect Transfers or Fixture Mount/Transfers remain attached to the implants when the closed-tray impression is removed from the mouth. The transfer is then retrieved from the implant, mated to the corresponding Implant Replica, and placed into its corresponding impression hole. To fabricate a working cast containing a replica of the implant in the patient's mouth, the impression is poured in dental stone.

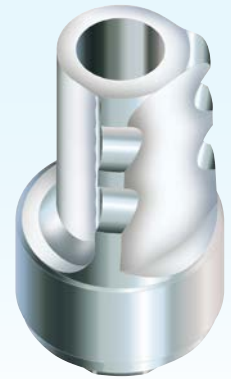

Indirect implant-level transfers
(purchased separately)

Fixture Mount/Transfers
(supplied with implant)



Exposing the Tops of the Implants

Remove the Surgical Cover Screws [SPMC, OPSC or OPWSC] with the 1.25 mmD Hex Tool.



Attaching the Transfers

Indirect Transfers and Fixture Mount/Transfers are available in a profile diameter corresponding to the Surgical Cover Screws supplied with the implant. The transfer components are used to transfer the anatomical soft tissue sulcus established by the healing of soft tissue around the Surgical Cover Screws.

Orient the flat side of the assembled transfer components toward the buccal surface, interdigitate its octagon or hexagon with the implant and press onto the implant. Thread the transfer screw into the implant and finger-tighten with the 1.25 mmD Hex Tool. This placement will transfer the orientation of the internal features and implant interface to the working cast.



Making the Transfer Impression

Take a radiograph or use a non-abrading explorer to verify that the transfer components are fully seated. Block out the hex holes in the tops of the components with medium of choice to prevent the ingress of impression material. Remove excess material so that the blockout is flush with the ends of the transfer. Failure to do so may prevent an accurate transfer procedure.

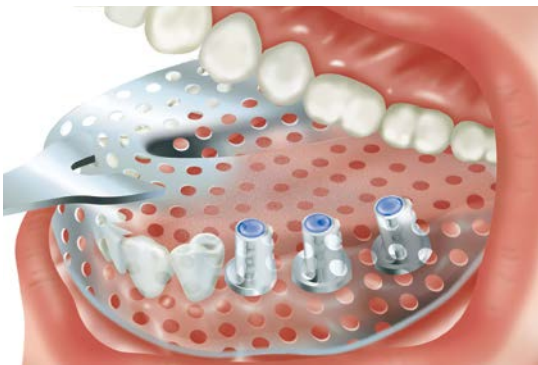

Verifying the Fit of the Impression Tray

Verify that the transfer components fit within the confines of the custom tray or the stock tray (shown) prior to injecting the impression material.



Injecting the Impression Material

An elastomeric impression material is recommended, such as vinyl polysiloxane. Inject light-body impression material around the transfers and fill the closed-tray with heavier body impression material. Make a full-arch impression, and allow the material to set according to the manufacturer's recommendations before removing. Unthread the transfer components from the implants in the patient's mouth. Make interocclusal records and an impression of the opposing arch. Send the impressions and transfer assemblies to the laboratory for fabrication of the working casts.

Replace the Surgical Cover Screws on the implants in the patient's mouth.

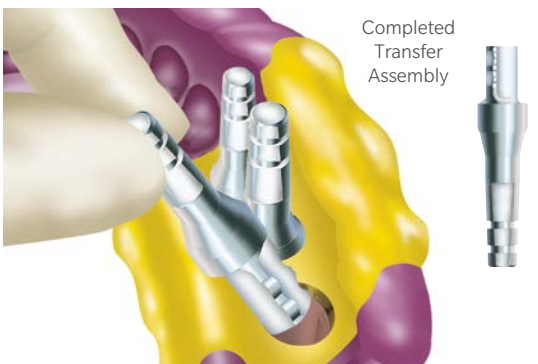

Completed
Transfer
Assembly

Seating the Transfer Assembly

Attach the Indirect transfers or fixture mounts to corresponding Implant Replicas with the 1.25 mmD Hex Tool:

- Implant Replica for an internal hex narrow Tapered SwissPlus Implant, 3.8 mmD platform: SPMR.
- Implant Replica for an internal octagon standard Tapered SwissPlus Implant, 4.8 mmD platform: OPR.

Align the flat side of each transfer with the flat side of its corresponding hole in the impression and insert the transfer assembly into the impression material. When using the transfers, a double click will indicate when the assembly has fully seated, or a single click if the fixture mounts were used to make the impression.

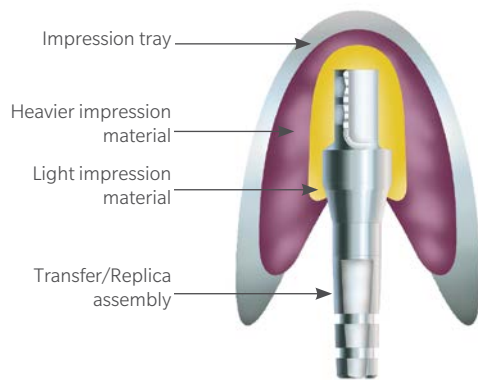

Cross Section of Transfer Impression

From the cross section of the Indirect Transfer impression, note that there is no access to the transfers from outside of the impression tray.

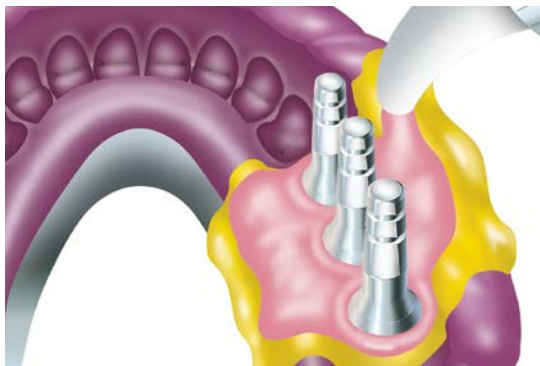

Fabricating the Working Cast

Place soft tissue replication material around the junctions of the assembled Implant Replicas and the transfers inside the impression. Take care not to cover the retention grooves of the Implant Replicas with the material.

After the material sets, pour the impression in dental stone.

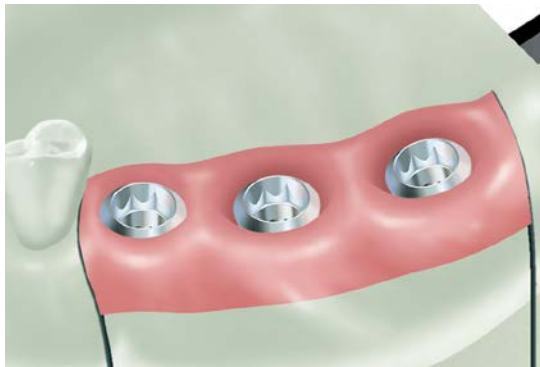

Fabricating the Working Cast

After the dental stone sets separate the cast from the impression. The Implant Replicas will be incorporated within the stone cast with the same octagon or hexagon positions and orientations as the implants in the patient's mouth. Unthread and remove the transfers from the Implant Replicas with the 1.25 mmD Hex Tool. The soft tissue replication material can be removed for a visual inspection of the abutment/implant replica connections, if desired.

Pour the opposing arch impression in dental stone, then utilize the interocclusal records to articulate the casts.

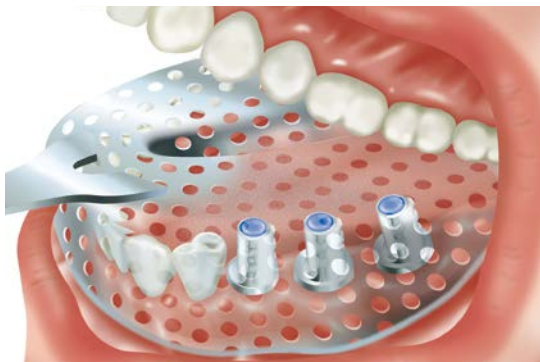

Alternative Direct (Open-Tray) Transfer Technique

For direct (open-tray) technique exchange components according to the following list:

- OPT/5 or OPT/6 - exchange supplied screw with WSX screw.
- FMT2 or FMTW2 - exchange supplied screw with WSX screw.
- FMTM2 - exchange supplied screw with DHTS screw.
- SPMT - exchange with fixture mount [FMTM2] and DHTS screw.

Immediate Impression Transfer Technique

Making an Impression at Time of Implant Placement

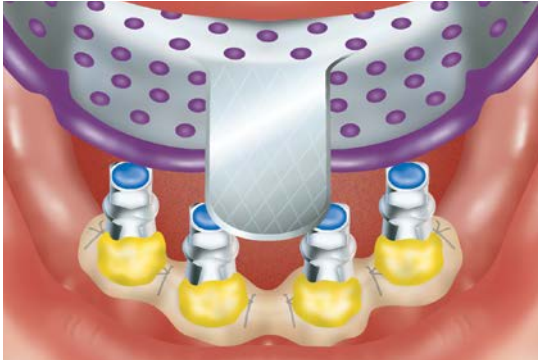

Making an Implant Level Impression

After placement, suture the soft tissue around the implants and attached Fixture Mount/Transfers. Block out the top of the Fixture Mount/Transfers. Place a covering of choice over the sutures to prevent them from getting trapped within the impression material. Inject light body impression material around the transfer and record a full-arch impression with standard body material.

Remove the impression after it fully sets. Unthread the fixation screws using the 1.25 mmD Hex Tool and remove fixture mounts.

Optional: Long impression screw [WSX for 4.8 mmD octagon platform and DHTS for 3.8 mmD hexagon platform] may be used for open-tray impression technique.

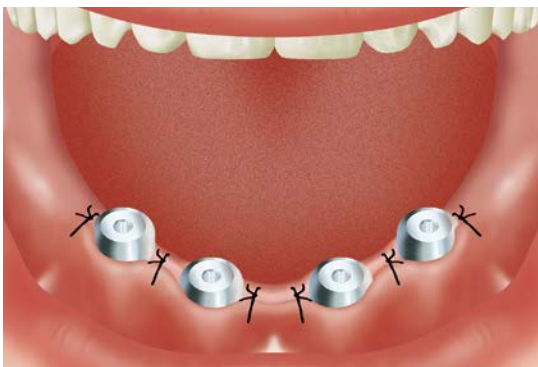

Attach Components for Healing Period

Attach Surgical Cover Screws using the 1.25 mmD Hex Tool. Care should be taken not to trap soft tissue between the mating components.

Forward the impression, transfer and diagnostic models to the laboratory for fabrication of the working cast.



Seating the Transfer Assembly

Attach the fixture mounts to corresponding Implant Replicas with the 1.25 mmD Hex Tool:

- Implant Replica for an internal hex narrow Tapered SwissPlus Implant, 3.8 mmD platform: SPMR.
- Implant Replica for an internal octagon standard Tapered SwissPlus Implant, 4.8 mmD platform: OPR.

Align the flat side of each Fixture Mount with the flat side of its corresponding hole in the impression and insert the transfer assembly into the impression material. A click will indicate when the assembly has fully seated.

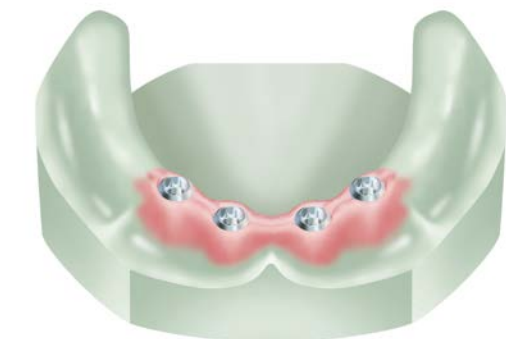

Fabricating the Working Cast

Place soft tissue replication material around the junctions of the assembled Implant Replicas and the Fixture Mount/Transfers inside the impression. After the material sets, pour the impression in dental stone. Separate the cast from the impression. The Implant Replicas will be incorporated within the stone cast with the same octagon or hexagon positions and orientations as the implants in the patient's mouth. Unthread and remove the Fixture Mount/Transfer from the Implant Replicas with the 1.25 mmD Hex Tool.

The soft tissue replication material can be removed for a visual inspection of the abutment/implant replica connections, if desired.

Pour the opposing arch impression in dental stone, then utilize the interocclusal records to articulate the casts.

Full-Contour Abutment System

Restorative Options with Full-Contour Abutments

Full-Contour Abutments are manufactured from titanium alloy and used as the support foundation for single- or multiple-unit cement-retained partially edentulous fixed restorations. These abutments consist of an abutment (fixation) screw and a full-contour preparable base with an apex that engages the implant with a non-rotational octagon or hexagon feature. The abutment base can be modified either chairside or in the laboratory to create a variety of contoured margins and abutment profiles to emulate the contours of the natural tooth it is replacing. Once prepared, these abutments are attached to the implant and impressed following conventional crown and bridge techniques. The full contour range of abutments are divided into three categories:

- 1) **Fixture Mount/Transfer:** Supplied with the implant, it engages either the internal octagon or hexagon of the implant. Used as the delivery mechanism during implant placement. It can then be used as the final abutment.
- 2) **Straight Abutment/Transfer:** Purchased as an option to the Fixture Mount/Transfer, this component functions first as a implant-level transfer and then as a final abutment. This component is available for the 4.8 mmD platform only.
- 3) **20° Angled Abutment:** To be utilized in cases where the angulation of the implants prevents the successful use of the above mentioned components. The components are available for the 4.8 mmD platform [\[OPH20\]](#) and the 3.8 mmD platform [\[SPH20\]](#).



Abutments for Tapered SwissPlus Internal Hex Implant, 3.8 mmD platform

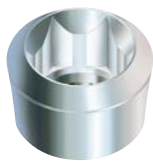

Abutments for Tapered SwissPlus Internal Octagon Implant, 4.8 mmD platform



Fixture Mount [\[FMSM\]](#)



20° Angled Abutment [\[SPH20\]](#)



Fixture Mount/Transfer Abutment [\[FMS or FMSW\]](#)



Straight Abutment/Transfer [\[OPA/5 or OPA/6\]](#)



20° Angled Abutment [\[OPH20\]](#)

Restorative Applications with the Full-Contour Abutments

Cemented Crown



Cemented Fixed Partial Denture

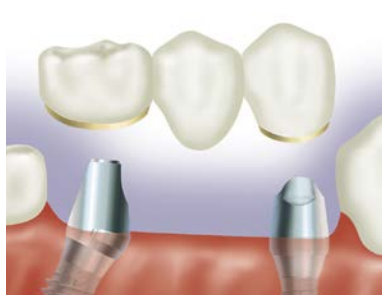

Cemented Fixed Partial Denture

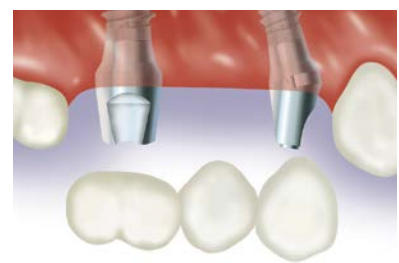

Straight Full-Contour Abutments for Fixed Partial Dentures

Straight Abutments for Tapered SwissPlus Implant System

Straight Full-Contour Abutments/Transfers are used for cemented single- and multi-unit restorations when the long axis of the implant is approximately 0° to 15° out of parallelism with the clinical long axis of the adjacent teeth. There must be acceptable soft tissue thickness to establish margins at least 0.5 mm subgingival for esthetics.

The Straight Abutments are divided into two categories:

- 1) Fixture Mount/Transfer:** During implant placement, the flat side of the fixture mount aids in the alignment of the internal octagon or hexagon, necessary for accurate orientation of the Angled Abutment. The Fixture Mount can be used as an implant-level transfer and finally as a Full-Contour Abutment. The profile diameter compliments the implant platform and body diameter and matches the profile of the supplied Surgical Cover Screw. The OPWB and SPWB series of implants have a 6.0 mmD fixture mount, the SPB series has a 5.2 mmD fixture mount and the SPMB series of implants has a 4.6 mmD fixture mount. The Fixture Mount/Transfer can be purchased separately. Now available in all sizes.
- 2) Straight Abutment/Transfer:** Supplied with a fixation screw [OPAS] which forms a 3 mmL extension to the component base, and with a circumferential groove for vertical retention within the closed-tray impression. After the impression is made the extension is sectioned off the fixation screw converting the transfer into a full contour abutment. The components [OPA/5 and OPA/6] have a profile diameter matching the profile of the Surgical Cover Screws (5.2 mmD and 6.0 mmD respectively), and are for the 4.8 mmD Octagon platform only.

Once the restorative components are in place, the minimum vertical clearance between the implant interface as measured from the height of contour and the opposing dentition is shown below.

NOTE: Make allowance for the thickness of the proposed restoration.

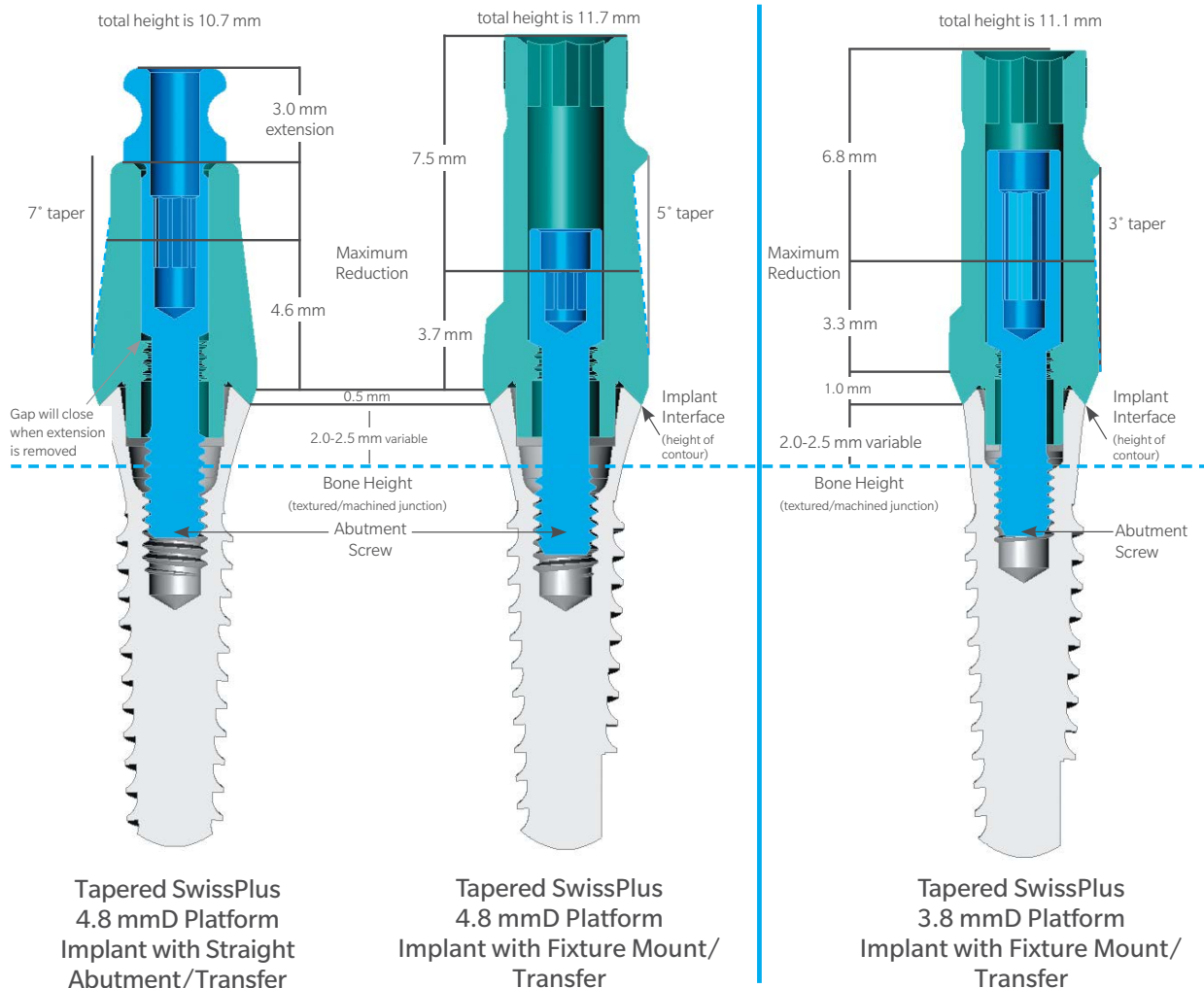

Angled Full-Contour Abutments for Fixed Partial Dentures

Angled Abutments for Tapered SwissPlus Implant System

Angled Abutments are used for cemented single- and multi-unit restorations when the long axis of the implant is approximately 15° to 30° out of parallelism with the clinical long axis of the adjacent teeth. There must be acceptable soft tissue thickness to establish margins at least 0.5 mm subgingival for esthetics.

The 20° Angled Abutment [OPH20] for internal octagon Tapered SwissPlus is packaged with a titanium alloy angled 5.2 mmD base and abutment screw [OPH20S]. The abutment [SPH20] for internal hexagon Tapered SwissPlus is packaged with a titanium alloy angled 4.6 mmD base and abutment screw [AH20S].

Once the restorative components are in place, the minimum vertical clearance between the implant interface as measured from the height of contour and the opposing dentition is approximately 3.7 mmL (as shown below).

NOTE: Make allowance for the thickness of the proposed restoration. The height of the implant interface (height of contour) above the crestal bone is a 2.0 mmL with the textured/machined surface junction relative to the crestal bone height.

These abutment assemblies are most effectively utilized and require minimum preparation when one flat of the implant octagon or hexagon is oriented toward the direction of the implant angulation at time of implant surgery. This design allows for 6 positional changes of 60° for the internal hexagon implants and 8 positional changes of 45° for the internal octagon implants.

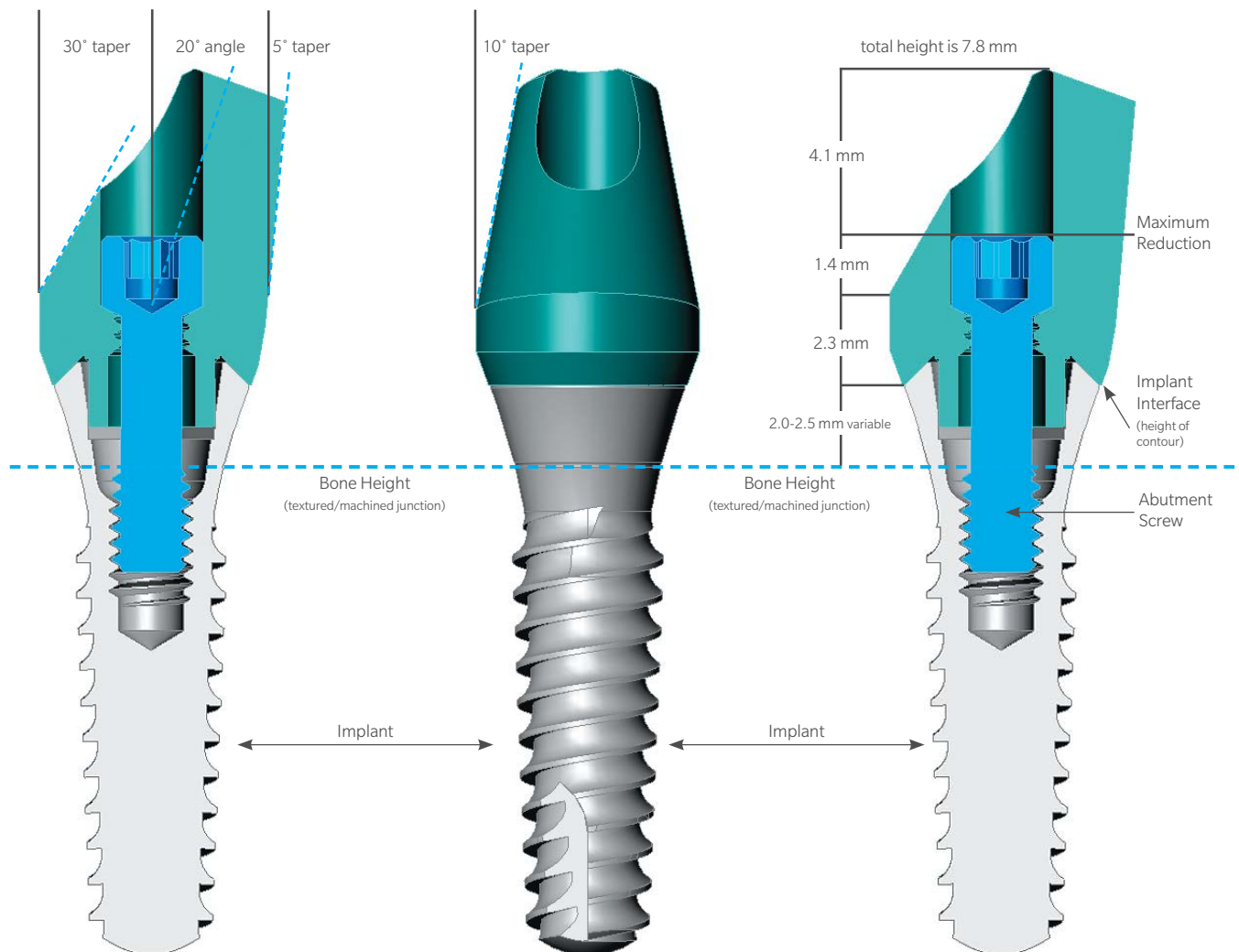

Full-Contour Abutment System

Selecting the Abutment

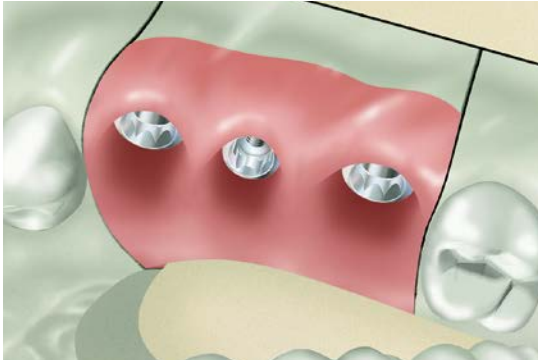

Selecting the Abutments

Fabricate the working cast utilizing one of the transfer procedures mentioned in the Impression Transfer section.

Abutments (“abutment”) consist of an abutment body and an abutment screw.

NOTE: the abutment should have the same profile as the Surgical Cover Screw used at time of implant placement.

Determine whether a Straight or Angled Abutment is needed depending on the angulation of the implants placed.

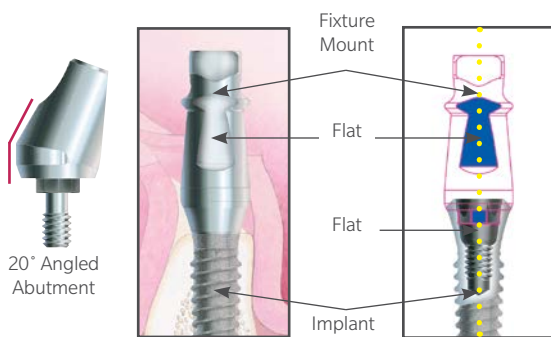

Using Angled Abutments

Confirm that implants that are incorrectly angled relative to the plane of occlusion have the internal octagon or hexagon oriented correctly for use of the Angled Abutment.

At time of implant placement the clinician will position the flat surface of the implant’s Fixture Mount/Transfer either toward or opposite the desired direction of the abutment angle. This will position the implant’s hex or octagon with a flat surface facing the angulation of the implant.

The two-piece 20° Angled Abutments [OPH20 or SPH20] are designed to function in this situation.

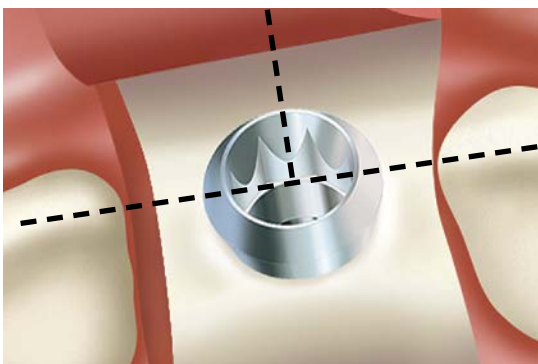

Selecting the Abutments

In the following sequence, Straight Abutments (Fixture Mount/Transfers could be used if available) for 4.8 mmD platform Tapered SwissPlus implants are used for the mesial and distal implants. The angulation of the middle implant will indicate the use of a 20° Angled Abutment for a 3.8 mmD platform Tapered SwissPlus Implant.

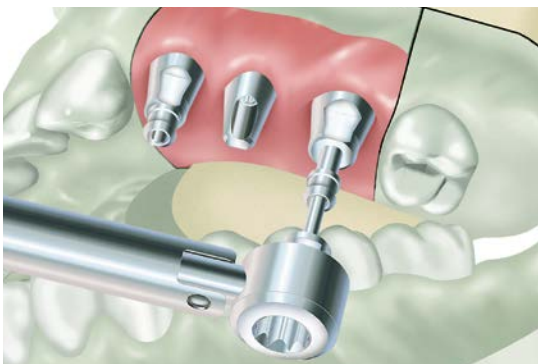

Seating the Abutments on the Working Cast

Interdigitate the abutment’s anti-rotational feature with the octagon or hexagon of the Implant Replicas in the working cast (or implant in the patient’s mouth) and place the abutment onto the Implant Replica (or implant). Thread the abutment screw through the abutment body and into the Implant Replica (or implant) with the 1.25 mmD Hex Tool. To complete seating tighten the abutment screw to 30 Ncm with a calibrated torque wrench.

Full-Contour Abutment System

Preparing the Abutment

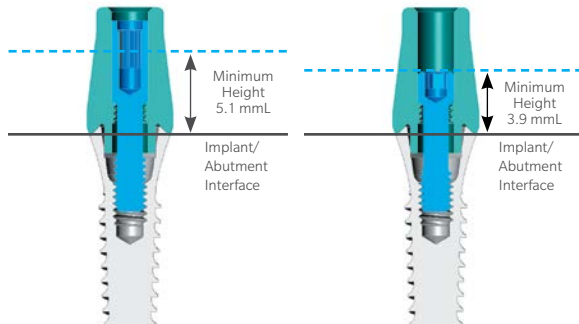

Fig. 5 Straight Abutment with standard abutment screw [OPAS].

Fig. 6 Straight Abutment with optional abutment screw [GPCAS].

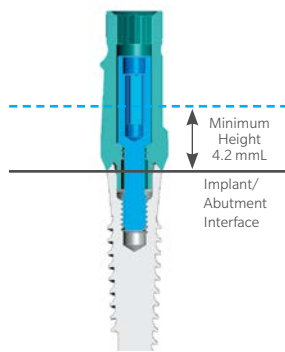

Fig. 7 Fixture Mount/Transfer

Fixation Screw showing 1.25 mmD Hex Tool with 1 mmL score line indicating maximum reduction

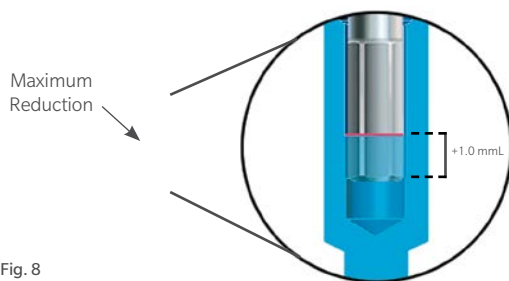

Fig. 8

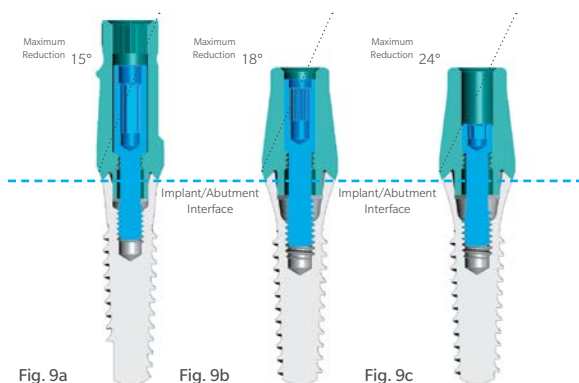

Fig. 9a

Fig. 9b

Fig. 9c

Determining Straight Abutment/Transfer Modifications

Straight Abutments [OPA/5 and OPA/6] for the 4.8 mmD platform only extend 7.7 mm vertically above the implant/abutment interface.

Visually determine the modifications necessary for establishing marginal and vertical contours. In order to preserve adequate hex engagement (1.0 mm) within the abutment fixation screw, do not vertically reduce the abutment by more than 2.6 mm (Fig. 5) from the top of the abutment. This reduction provides a vertical height of 5.1 mm above the internal octagon implant.

To reduce the abutment below this level, a lower profile, optional abutment screw [GPCAS] may be used (Fig. 6). This low-profile screw provides for a reduction to a vertical height of 3.9 mm above the internal octagon implant.

Determining Fixture/Transfer Modifications

Fixture mounts for the 3.8 mmD and 4.8 mmD platform Tapered SwissPlus Implants extend approximately 11.1 mm and 11.7 mm respectively above the top of the implant/abutment interface.

Reduce the height of the abutment relative to the accepted height adjustment of the fixation screw as described below. Reduction of the Fixture Mount/Transfer (Fig. 7) will produce an abutment 4.2 mm in height above the top of the Implant Replica (or implant) for both 3.8 mmD and 4.8 mmD platform implants.

Trimming the Abutment Screw

Mark a score line on the 1.25 mmD Hex Tool a little more than 1.0 mm from the apex (red line in Fig. 8). Trim the abutment screw vertically with regular placement of the 1.25 mmD Hex Tool into the hex-hole of the screw. As soon as the 1.0 mmL line on the tool is partially visible with the Hex Tool fully seated, discontinue trimming of the screw, maximum reduction has been achieved. Attach the screw and abutment to an Implant Replica and cut the abutment height to match the cut screw.

Preparing Abutments to Maximum Angle

Prepare abutments at an angle to achieve mutual parallelism and to create a favorable path of draw for the prosthesis.

Fig. 9a: Fixture Mount/Transfer of 3.8 mmD and 4.8 mmD platform implants can be trimmed to a maximum angle of 15° and 20° respectively with a margin height of 0.5 mm.

Fig. 9b: Straight Abutments for 4.8 mmD platform implants with profile diameters of 5.2 mm and 6.0 mm can be trimmed to a maximum angle of 18° with a margin height of 0.5 mm.

Fig. 9c: The above mentioned Straight Abutments used with an optional low-profile abutment screw [GPCAS], can be trimmed to a maximum angle of 24°.

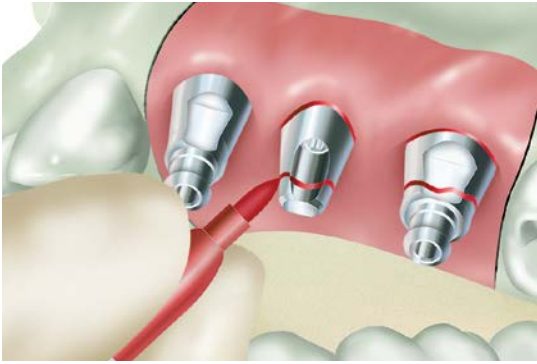

Marking the Abutment for Desired Preparation

Mark the required modifications on the abutment to achieve appropriate vertical clearance as well as gingival contours.

NOTE: the reduction of the abutment needs to take into consideration the following:

- 1) Type of restoration, example, a ceramic or metal margin
- 2) Desired thickness of alloy
- 3) Desired thickness of veneering material
- 4) Occlusal considerations: centric occlusion, protrusive or lateral excursion

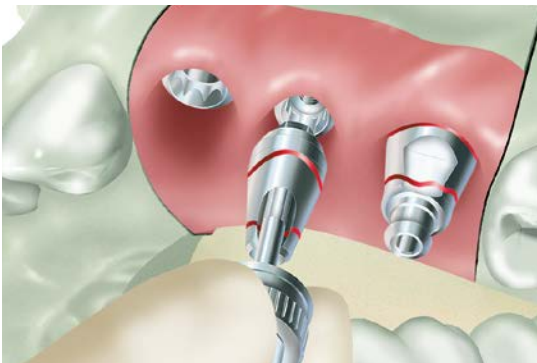

Removing the Abutment

Use the 1.25 mmD Hex Tool to loosen and remove the abutment screw.

NOTE: It is extremely important when using a variety of platforms and abutment types to keep the screws separate through the whole process.



Modifying the Abutments

Attach the abutment to an additional Implant Replica [OPR or SPMR] located within the Abutment Holder [ABTH]. Modify the abutment with cut-off disks, heatless stone wheels and 12-fluted carbide burs. Use a diamond bur to define the margins. Create a dimple on the buccal surface to help orient the abutment on the implant.

Preserve or redefine a flat surface as an anti-rotational feature. If modifying the abutments chairside, proceed to placing the prepared abutments.



Fabricating the Provisional Prosthesis

Replace the abutments on the working cast and make final adjustments. Take care not to damage the soft tissue material, which can be removed from the working cast, if necessary. If a diagnostic wax-up was made, make an alginate impression over it and pour the impression in dental stone. Mold a clear acrylic sheet onto the cast of the diagnostic wax-up according to the manufacturer's instructions. Remove the mold from the cast.

Occlude screw access holes and lubricate the abutments and working cast, then flow temporary material into the areas of the abutments and missing teeth in the mold. Seat the mold onto the cast containing the prepared abutments.

Trim the resulting provisional prosthesis and return it with the prepared abutments to the dentist.

Full-Contour Abutment System

Making the Impression



Placing the Prepared Abutments

Sterilize the prepared abutments according to standard clinical procedures before placing them into the patient's mouth. Interdigitate the hex or octagon of each abutment and implant utilizing the dimple to orient the abutment in the correct spatial position. Thread the abutment screw through the abutment body and into the implant with the Hex Tool.

Tighten each abutment screw to 30 Ncm with a calibrated torque wrench.

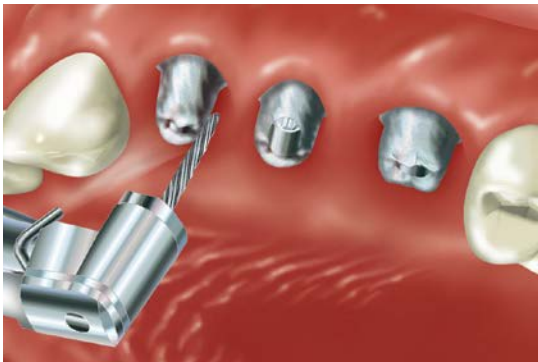

Making Final Adjustments to the Abutments

With a round-end, 12-fluted carbide bur in a high-speed handpiece, make minor modifications to the gingival and vertical contours of the abutments under copious irrigation.

After completing final modifications, retighten the abutment screws to the recommended torque. Take a radiograph to confirm that the abutments are fully seated.

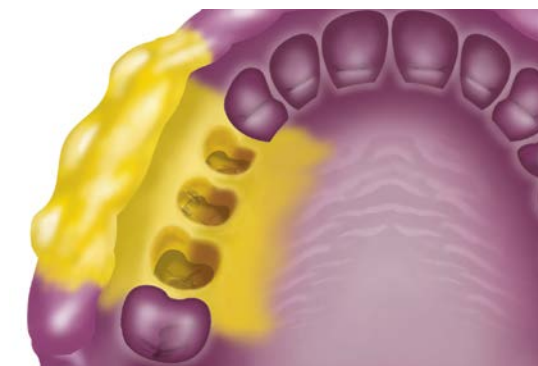

Making an Impression of the Prepared Abutments

Block out the hex-holes in the tops of the abutment screws with a medium of choice to prevent the ingress of impression material. Remove excess material so that the blockout is flush with the ends of the abutment screws. Make a conventional, full-arch, crown-and-bridge impression with an elastomeric impression material, such as vinyl polysiloxane. To insure a proper fit of the finished restoration, the abutments must remain in the patient's mouth after completing the impression procedure. Send the impression to the laboratory to fabricate a porcelain-fused-to-metal bridge.

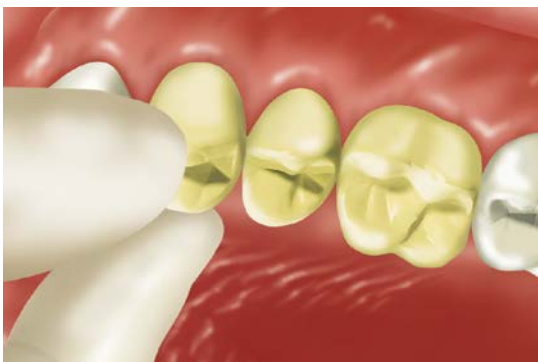

Cementing the Provisional Prosthesis

Block out the hex-holes in the tops of the abutment screws with material of choice. If the laboratory has fabricated a provisional prosthesis, cement it onto the prepared abutments with soft access cement.

If a provisional prosthesis has not been fabricated, block out any undercuts and lightly lubricate the abutments. Fabricate a prosthesis over the abutments chairside with a light-cure or autopolymerizing tooth colored acrylic material. For a more dense cure, remove the set provisional prosthesis from the mouth and place it in a curing unit. After curing, remove the restoration from the mold, trim and polish then cement the finished provisional prosthesis onto the abutments.

Full-Contour Abutment System

Fabricating the Framework Pattern



Pouring the Working Cast

Pour the standard crown-and-bridge impression in die stone. An epoxy die material may be useful if preparations are extremely thin. Separate the cast from the impression. Follow standard laboratory procedures to produce a soft tissue model. Utilize the inter-occlusal records to articulate the working cast with the opposing arch cast. Prepare the working cast for fabrication of the wax framework pattern.

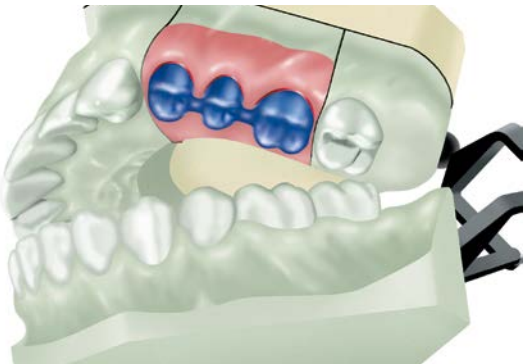

Fabricating the Wax Framework Pattern

Create the wax framework pattern according to routine crown-and-bridge procedures.



Spruing, Investing and Casting the Framework Pattern

Attach 10-gauge sprue wax with reservoirs to the thickest part of each unit within the framework pattern. Add auxiliary sprues and vents to prevent porosity in the casting, as needed.

Invest and cast the pattern in noble or high noble ceramic alloy according to the manufacturer's guidelines.

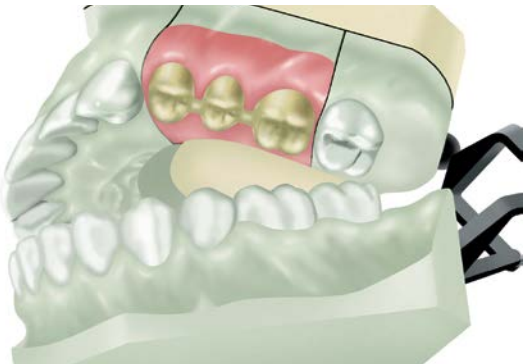

Finishing the Cast Framework

Divest the cast framework with ultrasonic cleaning and non-abrasive glass bead. Follow conventional laboratory techniques to fit and finish the cast framework. Seat the finished framework onto the working cast and confirm that a passive fit has been achieved. Place the framework on the working cast and send it to the clinician for a try-in of the metal framework.

The dentist should confirm that a passive fit has been achieved before the veneering material is applied.

Full-Contour Abutment System

Seating the Final Restoration



Trying in the Finished Framework

Remove the provisional restoration from the patient's mouth. Retorque the abutment screws to 30 Ncm with a calibrated torque wrench. Seat the finished framework onto the abutments. Verify that it fits passively, and that no additional finishing or adjustment is required. Remove the framework. Reseat the provisional prosthesis with soft-access cement.

Return the framework to the laboratory on the working cast for completion of the fixed partial denture.

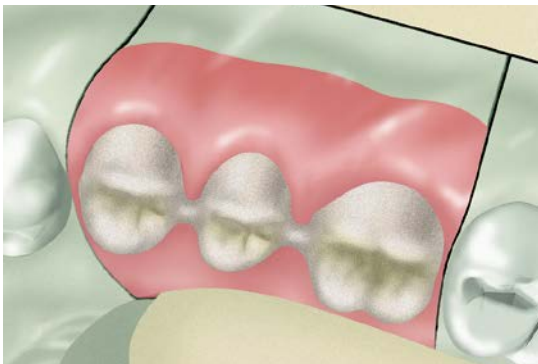

Applying the Porcelain (Veneering Material)

Prepare the framework to receive the opaque layer according to routine laboratory procedures.

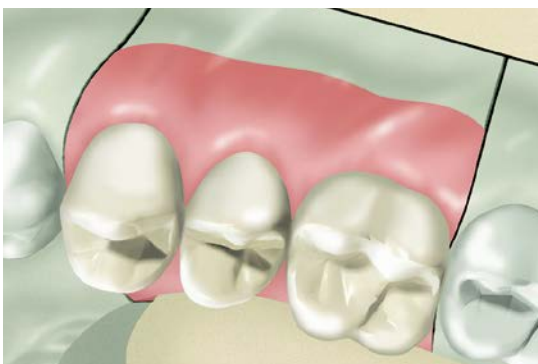

Finishing the Final Prosthesis

Apply porcelain to the framework according to routine laboratory procedures.

Finish the porcelain and polish any metal margins, seat the finished prosthesis on the working cast and send it to the clinician for final delivery.



Delivering the Final Prosthesis

Remove the provisional restoration from the patient's mouth. Retorque the abutments to 30 Ncm with the calibrated torque wrench. Wait ten minutes, then retighten. This is done to compensate for clamping force lost due to screw embedment. Seal the screw access channel in each abutment with cotton pellets and light-curing resilient material or gutta percha. This will ensure future access to the screw head. Seat the final prosthesis onto the abutments and confirm fit and contour. Check the occlusion. Verify that no additional finishing or adjustment is required. Cement the final prosthesis with a cement of choice. To facilitate future retrievability, a soft-access cement may be used.

Provide the patient with oral hygiene instructions prior to release.

Narrow Abutment System

Restorative Options with Narrow Abutments

Narrow Abutments are used for cemented single- and multi-unit restorations when the long axis of the implant is approximately parallel with the clinical long axis of the adjacent teeth and/or implant/abutment combination. There must be acceptable soft tissue thickness to establish margins at least 0.5 mm subgingival for esthetics. The abutments are supplied with a plastic component which can be used as a transfer as well as a waxing coping.

These abutments require minimum preparation and consist of the following two options:

- 1) One-Piece Narrow Abutments (does not engage the internal anti-rotational area of implant interface)

[OPA]:

Used for multiple-unit restorations only. This abutment is attached to the implant and its spatial position is transferred to a working cast with a direct impression technique. The abutment is to be left in the patient's mouth once its position has been transferred. A provisional restoration is fixed over the abutments during prosthesis fabrication. The abutment is designed superiorly with 6° round tapering walls and a single flat 3° tapered side. The base portion of the abutment interfaces with the 8° internal bevel and thread of the implant. Tightened into the implant with a 1.25 mmD Hex Tool, the abutment forms a seal with the 3.5 mmD opening at the most superior aspect of the implant. The abutment functions as a support and the circumference of the implant platform will function as the margin for the prosthesis. If required, preparation of the abutment is achieved chairside or with copious irrigation, intraorally.

- 2) Two-piece abutment components (engages the internal anti-rotational area of implant interface):

Used for single- or multiple-unit restorations. This abutment can be attached to the implant and function similar to a One-Piece Abutment (mentioned above).

A preferable alternative is to make an implant level impression and attach the abutment to the Implant Replica in the working cast. The prosthesis is fabricated on the Two-Piece Narrow Abutment and respective Implant Replica in the working cast.

- Two-Piece Narrow Abutment for the standard 4.8 mmD platform **[OPA2]:**

The abutment head is designed superiorly with 6° round tapering walls and a single flat 3° tapered side. The tapered inferior aspect of the abutment has an octagon which interfaces with the 3.0 mmD (flat-to-flat) internal octagon as well as the 8° internal tapered walls of the implant. Fixed to the implant with an abutment screw **[GPCAS]** it forms a seal with the 3.5 mmD opening at the most superior aspect of the implant. The abutment functions as a support and the circumference of the implant platform will function as the margin for the prosthesis.

- Two-Piece Narrow Abutment for the narrow 3.8 mmD platform **[SPMA2]:**

The abutment head has 4° round tapering walls with a set of opposing tapering flat surfaces and is fixed to the implant with an abutment screw **[MHLAS]**. Designed to interface with the 2.5 mmD (flat-to-flat) internal hexagon and seal the 2.9 mmD aperture of the narrow platform Tapered SwissPlus Implant. Used in areas of limited mesial-distal restorative space the abutment assembly functions as a support for the prosthesis, and can be prepared chairside or in the laboratory.



Abutment for the
Internal Hexagon Implant,
3.8 mmD Platform

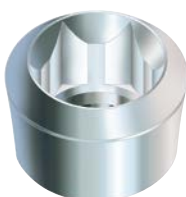

2-piece Narrow
Abutment
[SPMA2]

Abutments for the
Internal Octagon Implant,
4.8 mmD Platform



1-piece Narrow
Abutment
[OPA]



2-piece Narrow
Abutment
[OPA2]

Preparation Guidelines for Narrow Abutments

Vertical Height Requirements of the Final Abutment Assembly

To allow for an esthetic, subgingival connection between the implant and prosthesis interface, determine the appropriate tissue depth on the labial or buccal surface. The prosthesis margin is determined by the height of contour of the implant.

The vertical height from the implant platform to the top of the abutment measures 5.7 mm and 5.1 mm above the 4.8 mmD and 3.8 mmD implant platforms respectively.

After the abutment components are in place, the minimum vertical clearance between the implant interface (measured from the implant height of contour) and the opposing dentition is 3.85 mm for internal octagon implants with 4.8 mmD platform, and 3.7 mm for internal hexagon implants with 3.8 mmD platform. This measurement is taken from the platform to the point of maximum reduction of the abutment or abutment head/screw combination, and it does not include the vertical space required for prosthesis fabrication.

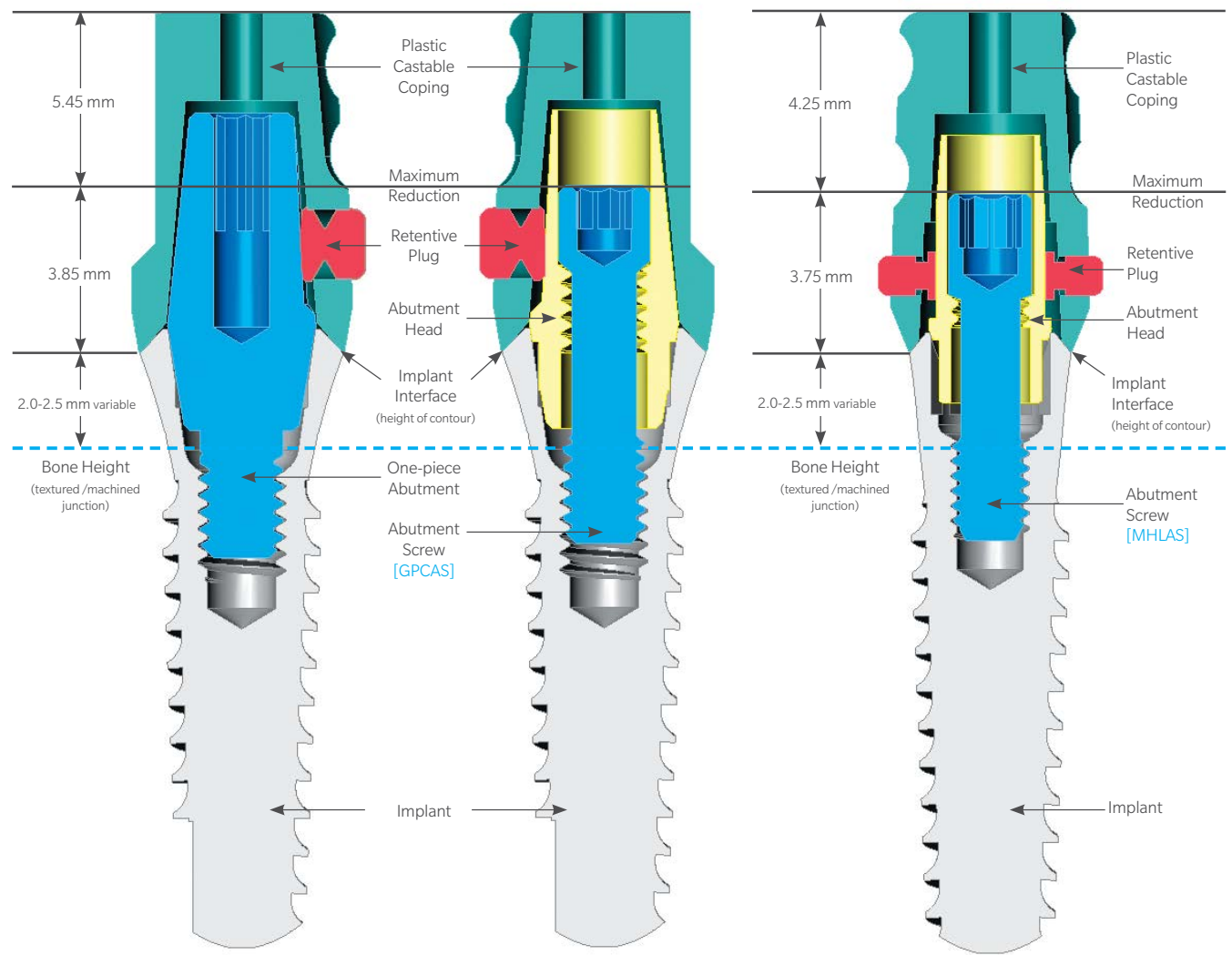

**Tapered SwissPlus
4.8 mmD Platform Implants
One-Piece [OPA] or Two-Piece [OPA2] Narrow Abutment**

**Tapered SwissPlus
3.8 mmD Platform Implants
Two-Piece Narrow Abutment [SPMA2]**

Components for 4.8 mmD Platform Tapered SwissPlus Implant

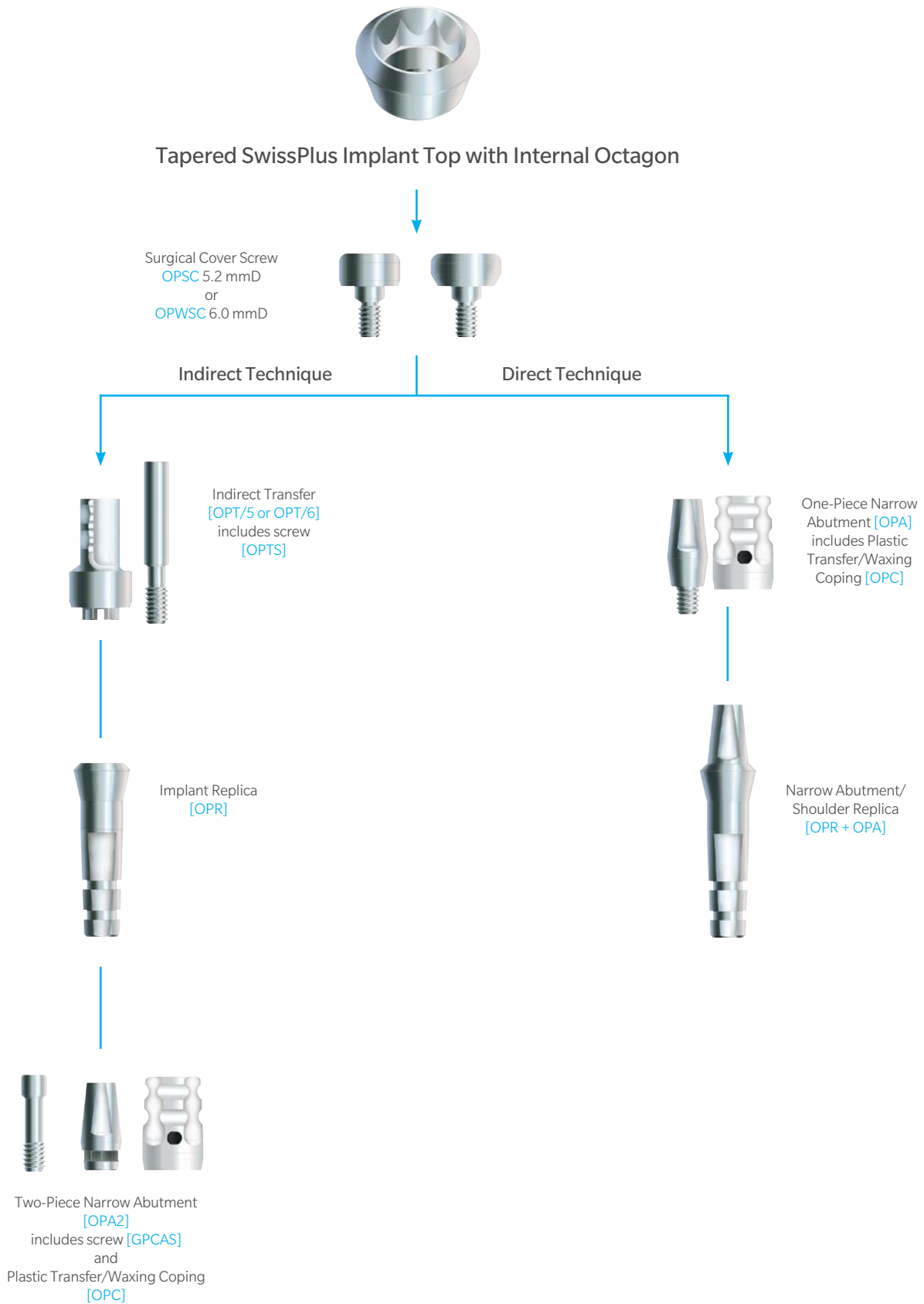

Components for 3.8 mmD Platform Tapered SwissPlus Implant

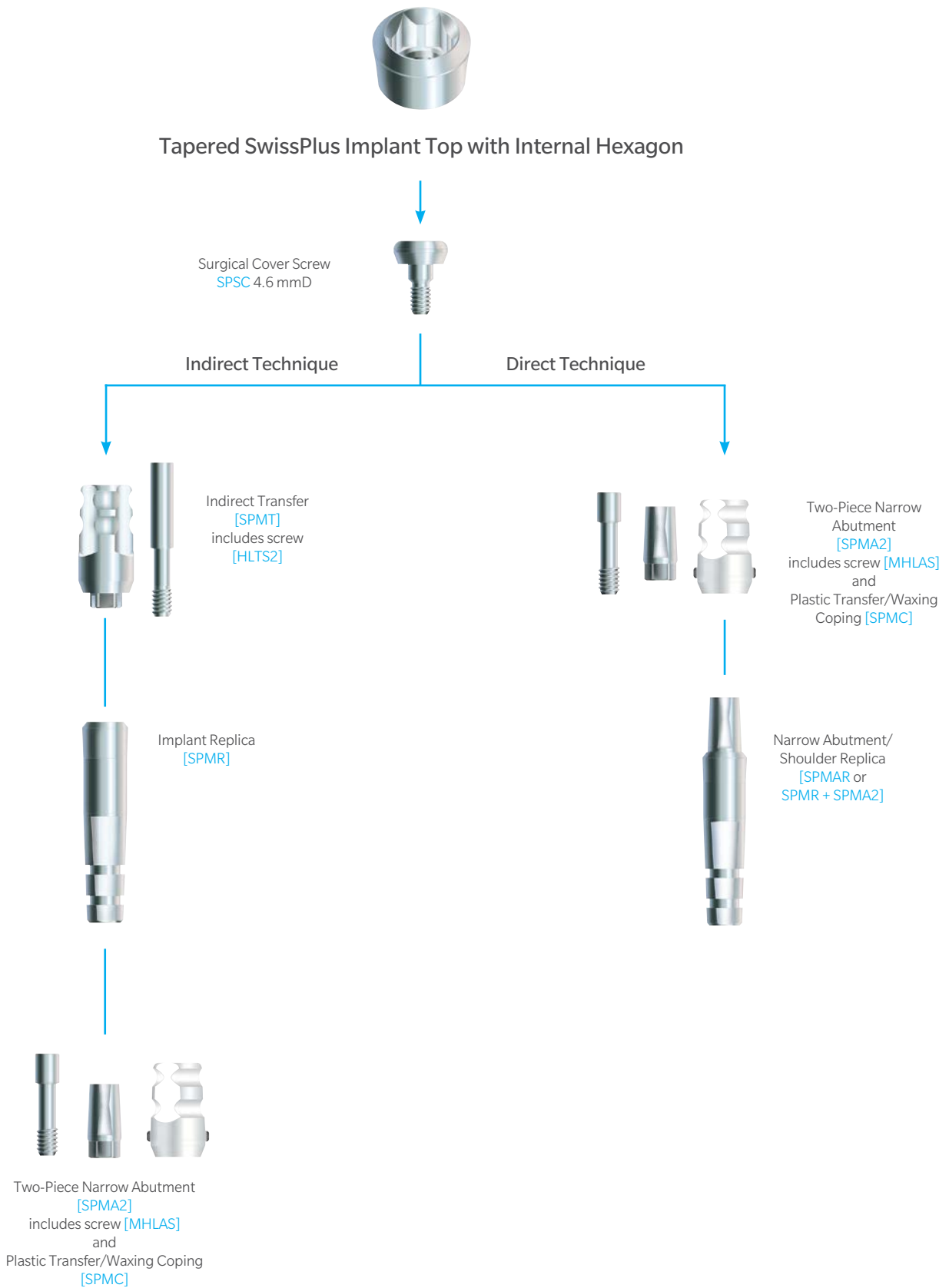

Option 1: Direct Technique - Attaching and Preparing the Abutment

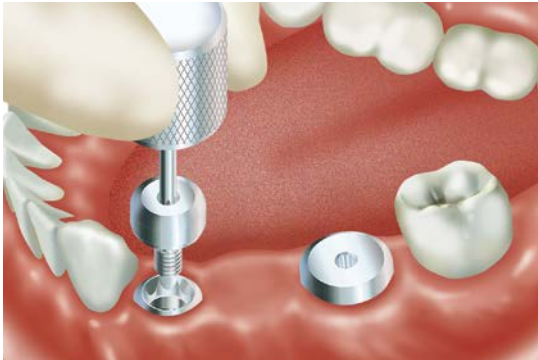

Exposing the Tops of the Implants

After the healing period, remove the Surgical Cover Screw with a 1.25 mmD Hex Tool. With a tissue-level implant there is no need to “uncover” the implant so the cover screw is easily accessible.

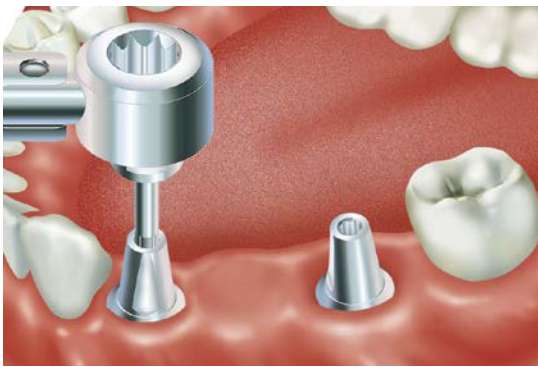

Attaching the Narrow Abutments

Attach either one-piece [OPA] or two-piece [OPA2 or SPMA2] Narrow Abutments to the implants with a 1.25 mmD Hex Tool. Tighten the abutments to 30 Ncm with a calibrated torque wrench.

NOTE: For ease of use orient the flat of the two-piece abutment to the facial. This alignment will aid in the orientation of the Plastic Transfer/ Coping [OPC or SPMC]. If using the one-piece abutment, orientation of the flat is determined by the thread timing of the internal thread of the mating implant and thread of the abutment.

Standard impression procedures with the Plastic Transfer will follow this step if no preparation of the abutments is required.



Modifying the Narrow Abutments

Use a marker to indicate the vertical reduction required.

Remove the marked abutment from the mouth if major reduction in profile is required and prepare the abutment chairside.

Attach the abutment to an Implant Replica [OPR or SPMR] and insert assembly into the Abutment Holder [ABTH]. Modify the abutment with cut-off disks, heatless stone wheels and 12-fluted carbide burs.

Caution: Do not reduce the abutment lower than indicated in the guidelines on the prior pages.

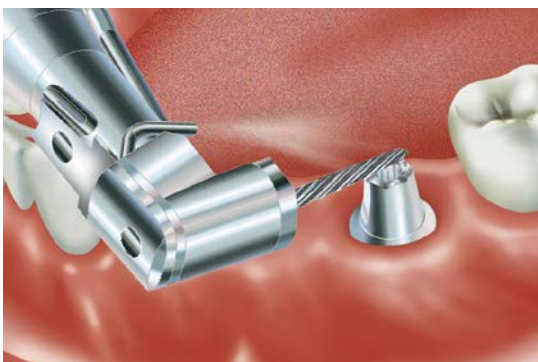

Making Final Adjustments to the Abutments

Reattach, then tighten the abutments to 30 Ncm with a calibrated torque wrench.

Confirm vertical clearance and common path of draw of proposed restoration relative to surrounding dentition and/or implants. If required, make minor modifications to the abutments under copious irrigation.

After completion of final modifications, retighten the abutments to the recommended torque.

NOTE: Clearly mark on the impression and laboratory work authorization slip that the abutments have been modified.

Option 1: Direct Technique - Preparing the Transfer Coping



OPC



SPMC

Attaching the Plastic Transfer Copings

Attach the respective Plastic Transfer Coping [OPC for 4.8 mmD platform implants and SPMC (has two black plugs) for 3.8 mmD platform implants]. The black plug(s) on the Plastic Transfer Coping will align with the flat(s) on the abutments for rotational stability.



Modifying the Plastic Transfer Coping

Trim the Plastic Transfer Coping to the exact vertical height and contour of the prepared Narrow Abutment.

Follow procedures as if using a reduction coping in standard crown and bridge techniques. With this procedure the clinician will trim the abutment then the coping.



Reactivating the Plastic Transfer Coping

Remove the Plastic Transfer Coping from the abutment after it has been trimmed to the correct contour.

Reactivate the copings prior to making the impression. Roll the plastic component on a flat surface which will align the outer portion of the black plug flush with the outside profile of the coping. The plug is now in position to be carefully realigned with the flat of the abutment, and press-fit into place.

NOTE: The above procedure only applies to the component [OPC] which has one black plug.

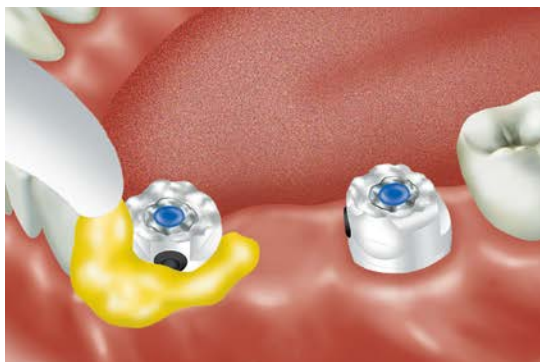

Making an Impression of the Prepared Abutments

Block out the hex-holes in the tops of the abutments and/or abutment screws with a medium of choice to prevent the ingress of impression material. Remove excess material so that the blockout is flush with the tops of the abutments. Make a conventional, full-arch, crown-and-bridge impression with an elastomeric impression material, such as vinyl polysiloxane. To insure a proper fit of the finished restoration, the abutments must remain in the patient's mouth after completing the impression procedure.

Remove the impression with enclosed Plastic Transfer Copings and send the impression to the laboratory for fabrication of the working cast.

Option 1: Direct Technique - Fabricating the Working Cast

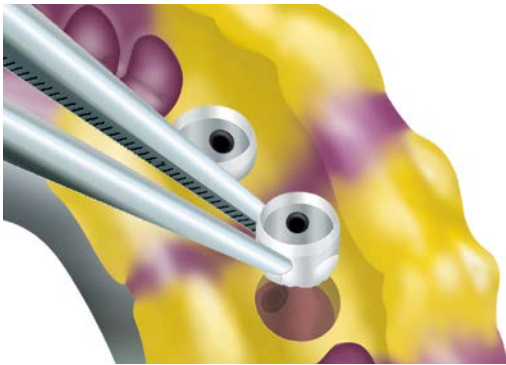

Removing the Plastic Transfer Copings

Abutments that have been modified in any way will have to have their corresponding Narrow Abutment/Shoulder Replica [OPR + OPA; SPMAR or SPMR + SPMA2] reduced to the identical profile prior to pouring of the working cast.

Use tweezers to carefully remove the Plastic Transfer Copings from within the impression. The copings will provide visual indication of which abutments have been trimmed orally as well as allow the technician to reactivate the OPC black plug as previously instructed.



[OPR + OPA;
SPMAR or
SPMR + SPMA2]



Trimming the Narrow Abutment/Shoulder Replica

Attach the Plastic Transfer Coping to the corresponding Narrow Abutment/Shoulder Replica [OPR + OPA; SPMAR or SPMR + SPMA2].

Insert the assembly into the Abutment Holder [ABTH] and fasten in place.

Precisely trim the aluminum replica to the profile of the plastic coping, taking care not to heat or cut the plastic. If major reduction is required, mark the replica with a fine instrument, remove the plastic coping and then trim. The trimmed plastic coping is used as a reduction coping for the aluminum replica.



Fabricating the Working Cast

Reactivate the black plug* of the Plastic Transfer Coping and then align the plug with the flat side of the replica, and press-fit the two pieces together.

Place the assembly back into the impression ensuring correct orientation of the plug and the flat surfaces of the coping. Pour the working cast in dental stone with soft tissue replication material.

*This procedure is only for the coping [OPC] with a single plug.



Fabricating the Working Cast

After the dental stone sets, separate the cast from the impression. The trimmed Narrow Abutment/Shoulder Replica will be incorporated within the stone cast with the same orientation as the abutments in the patient's mouth.

The soft tissue replication material can be removed for a visual inspection of the abutment/implant shoulder interface, if desired.

Pour the opposing arch impression in dental stone, then utilize the interocclusal records to articulate the casts.

Proceed to common procedures for fabricating the framework pattern on page 54.

Option 2: Indirect Technique - Attaching the Abutment

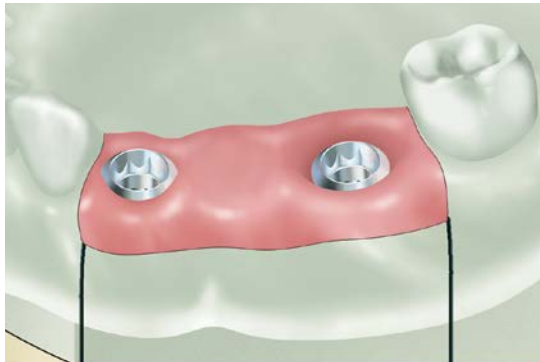

Selecting the Narrow Abutments

Fabricate the working cast utilizing one of the transfer procedures mentioned in the Impression-Taking section. Two-Piece Narrow Abutments (“abutment”) consist of an abutment body with either a base octagon [OPA2] or hexagon [SPMA2] and an abutment screw [GPCAS or MHLAS] respectively.

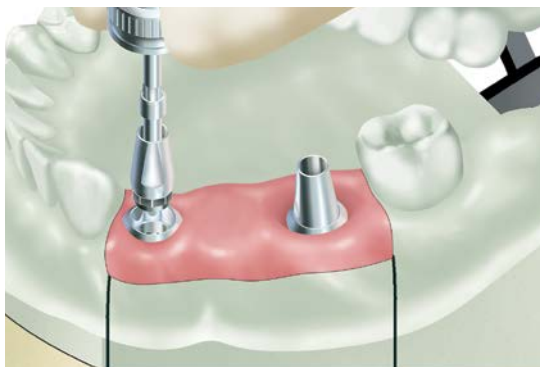

Seating the Narrow Abutments

Interdigitate the abutment’s engaging component with that of the Implant Replica in the working cast. Thread the abutment screw through the abutment body and into the Implant Replica with the 1.25 mmD Hex Tool.

To complete seating, tighten the abutment screw to 30 Ncm with a calibrated torque wrench.

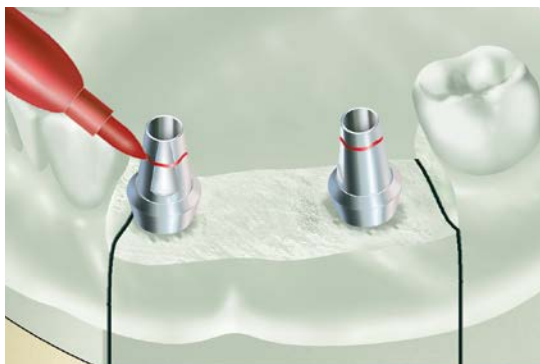

Mark the Abutment for Desired Preparation

Mark the required modifications to achieve appropriate vertical clearance.

NOTE: The reduction of the abutment needs to take into consideration the following:

- 1) Desired thickness of casting alloy.
- 2) Desired thickness of veneering material.
- 3) Occlusal considerations such as centric occlusion and protrusive or lateral excursions.

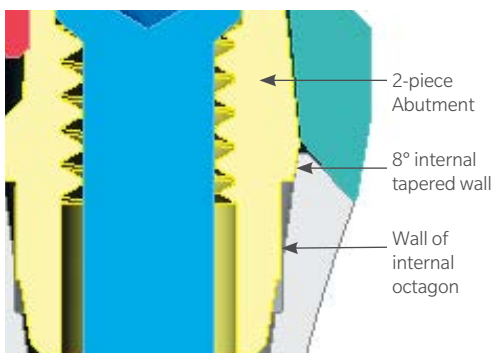

Removing the Narrow Abutments

The male octagon or hexagon of the abutment [OPA2, SPMA2] will engage the internal octagon or hexagon of the Implant Replica [OPR, SPMR].

NOTE: Due to the contact of the OPA2 with the internal octagon and the 8° bevel, a frictional connection often occurs with the implant or Implant Replica.

Optional Step: To remove the abutment [OPA2] first remove the abutment screw, then fully seat the Removal Tool [HLRTX2] to back the abutment off the Implant Replica or Implant.

Option 2: Indirect Technique - Preparing the Abutments



Modifying the Narrow Abutments

Attach the abutment to an additional Implant Replica [OPR or SPMR] located within the Abutment Holder [ABTH]. Modify the abutment with cut-off disks, heatless stone wheels and 12-fluted carbide burs.

Keep modification to vertical reduction only if possible.



Attaching the Abutments

Attach the Narrow Abutments to the corresponding Implant Replica's. Tighten to the required torque with a calibrated torque wrench. Close the articulator and confirm desired clearance in all excursive and centric movements.



Attaching the Plastic Transfer Copings

The Narrow Abutments [OPA2 and SPMA2] are supplied with a Plastic Transfer Copings [OPC and SPMC] which are used as the foundation for the prosthesis framework fabrication.



Modifying the Plastic Transfer Coping

Trim the Plastic Transfer Coping to the exact vertical height and contour of the prepared 2-piece Narrow Abutment.

Follow procedures as if using a reduction coping in standard crown and bridge techniques. With this procedure, the technician will trim the abutment then the coping.

Proceed to common procedures for fabricating the framework pattern on page 54.

Common Procedures for Fabricating the Framework Pattern



Seating the Plastic Copings

Attach the Plastic Copings on the the prepared components. Depending on what process has been used will determine the components in the working cast:

Option 1: Direct technique will have prepared Narrow Abutment / Shoulder replica in working cast.

Option 2: Indirect technique will have prepared 2-piece Narrow Abutments attached to the corresponding Implant Replica in working cast.



Removing the Retentive Plug

The black plug provides an intimate contact between the tapered wall(s) of the Narrow Abutment and the plastic coping.

It is designed as a retentive feature for transfer procedures as well as an anti-rotational feature when utilizing this component for framework fabrication of single-unit restorations. Once seated the black plug can be fused in position to the coping by melting the components with a hot instrument.

Trim the internal retentive feature or remove the black plug completely prior to the wax up of the multi-unit framework.

NOTE: The hole left by the removal of the plug needs to be filled completely prior to investing.

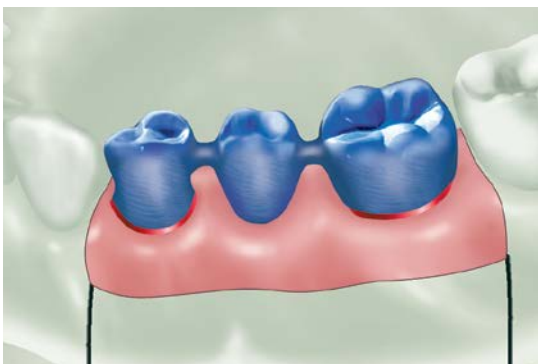

Fabricating the Wax Framework Pattern

Trim excess bulk from the plastic coping to allow for an even thickness of veneering material between the final framework and adjacent and opposing dentition.

Create the wax framework pattern according to routine crown-and-bridge procedures.

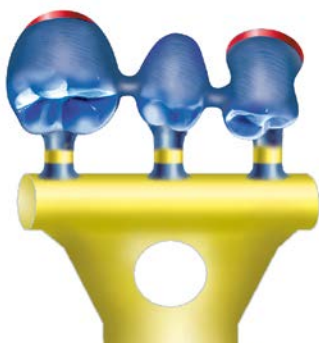

Spruing, Investing and Casting the Framework Pattern

Attach 10-gauge sprue wax with reservoirs to the thickest part of each unit within the framework pattern. Add auxiliary sprues and vents to prevent porosity in the casting, as needed.

Invest and cast the pattern in noble or high noble ceramic alloy according to the manufacturer's guidelines.

Common Procedures for Fabricating the Final Prosthesis



Finishing the Cast Framework

Divest the cast framework with ultrasonic cleaning and non-abrasive glass bead. Follow conventional laboratory techniques to fit and finish the cast framework. Seat the finished framework onto the working cast and confirm that a passive fit has been achieved.

Place the framework on the working cast and send it to the clinician for a try-in of the metal framework. The dentist should confirm that a passive fit has been achieved before the veneering material is applied.



Finishing the Final Prosthesis

Prepare the framework to receive the opaque layer and apply porcelain to the opaqued framework according to routine laboratory procedures.

Finish the porcelain and polish any metal margins, seat the finished prosthesis on the working cast and send it to the clinician for final delivery.

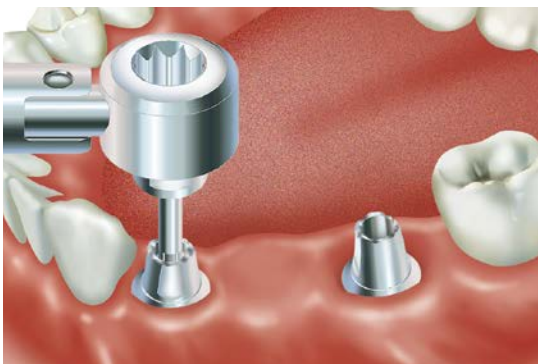

Delivering the Final Prosthesis

Remove the provisional restoration from the patient's mouth. Retorque the abutments to 30 Ncm with the calibrated torque wrench. Wait ten minutes, then retighten. This is done to compensate for clamping force lost due to screw embedment.



Delivering the Final Prosthesis

Seal the screw access channel in each abutment with cotton pellets and light-curing resilient material or gutta percha. This will ensure future access to the screw head. Seat the final prosthesis onto the abutments and confirm fit and contour.

Check the occlusion. Verify that no additional finishing or adjustment is required.

Cement the final prosthesis with a cement of choice. To facilitate future retrievability, a soft-access cement may be used. Provide the patient with oral hygiene instructions prior to release.

“Cast-To” Gold Abutment System

Restorative options with “Cast-To” Gold Abutments

“Cast-To” Gold Abutments are used to fabricate implant-level, custom cast restorations that provide subgingival margins for esthetics, reduced height for vertical occlusal clearance and/or custom angles. These abutment assemblies consist of either an octagon- or hex-engaging gold base, an abutment screw and a castable press-fit Plastic Sheath.

The press-fit Plastic Sheath is modified and incorporated into the wax framework pattern. After investing, the wax and Plastic Sheath are burned out of the pattern following the lost wax process. When molten alloy is cast into the investment mold, the base component is incorporated into the casting and provides a machined interface that mates directly with the implant. The finished casting can be used as a custom abutment that receives a cemented single- or multiple-unit restoration, or it can be veneered and used as a single-unit, screw-retained, combined abutment-and-crown. Caution: Multi-unit, screw-retained restorations cannot be fabricated with these abutments; use Non-Engaging Abutments for these types of restorations.

The gold base is fabricated from a non-oxidizing alloy that promotes chemical adhesion of the cast alloy, but does not permit the adhesion of porcelain. Therefore, a porcelain bonding alloy must be added to all areas of the gold base where porcelain veneering is desired.



Screw-retained Crown

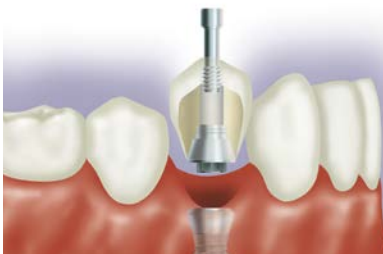

Custom Angled Abutment



Custom Abutments

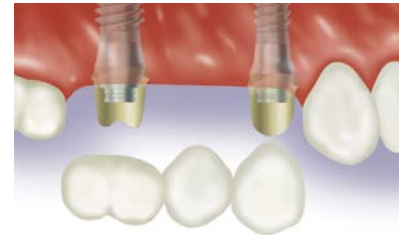

Abutment for the Internal Octagon Implant, 4.8 mmD platform



“Cast-To”
Gold
Abutment
[OPGA]

Abutment for the Internal Hex Implant, 3.8 mmD platform

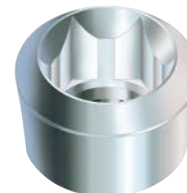

“Cast-To”
Gold
Abutment
[SPGA]

Vertical Height Requirements for “Cast-To” Gold Abutments

“Cast-To Gold Engaging Abutments for Tapered SwissPlus Implant Systems

“Cast-To” Gold Abutments [OPGA] for internal octagon Tapered SwissPlus with a 4.8 mmD platform and [SPGA] for internal hexagon Tapered SwissPlus with a 3.8 mmD platform, allow for a low profile connection to the tissue-level implant platform.

The abutment [OPGA] is packaged with a gold base, a 3.8 mmD plastic castable sheath [OPS] and an abutment screw [GPCAS].

The abutment [SPGA] is packaged with a gold base, a 3.8 mmD plastic castable sheath [OPS] and an abutment screw [MHLAS].

Once all the restorative components are in place, the minimum vertical clearance between the implant interface as measured from the height of contour and the opposing dentition is 3.85 mm and 4.1 mm respectively (as shown below). The height of the implant interface above the crestal bone is 2.0 mmL with the textured/machined surface junction relative to the crestal bone height.

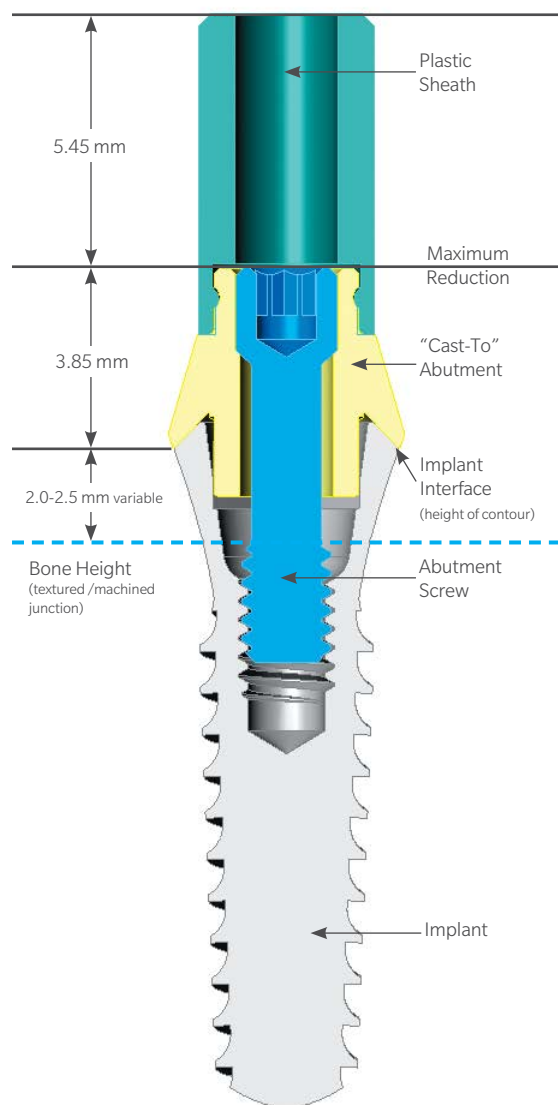

Tapered SwissPlus
4.8 mmD Platform Implants
[OPGA]

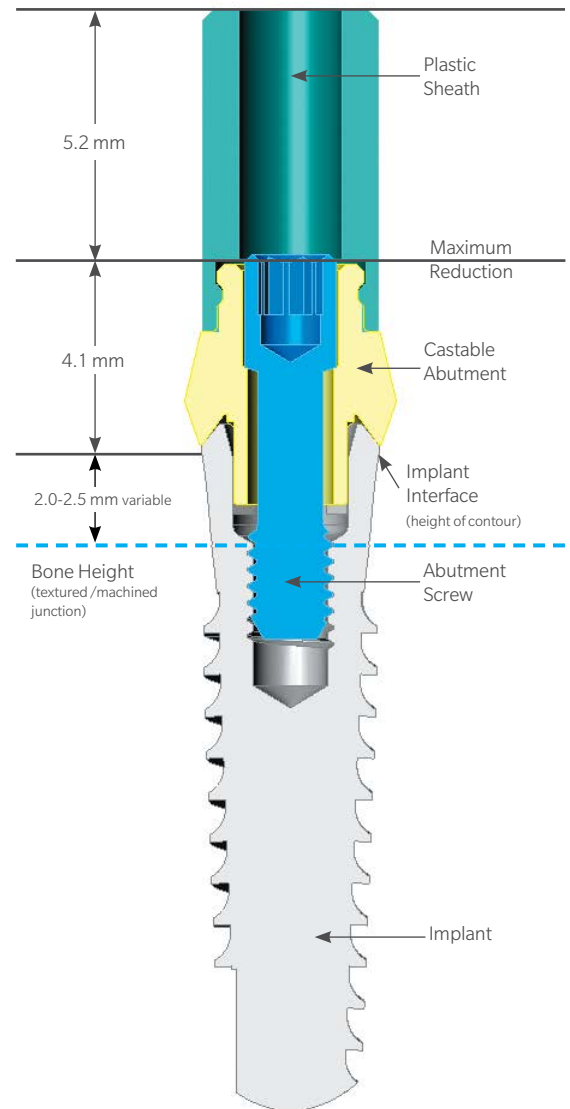

Tapered SwissPlus
3.8 mmD Platform Implants
[SPGA]

Fabricating Single-unit Framework Patterns

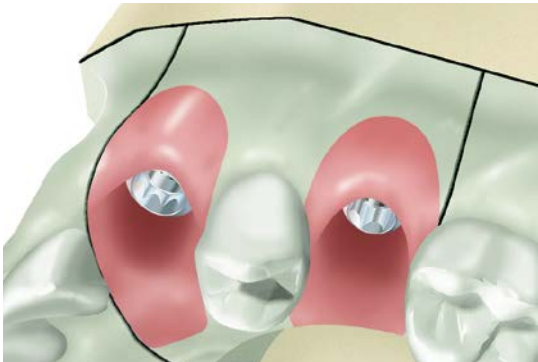

Selecting the “Cast-To” Gold Abutment

Fabricate the working cast utilizing one of the transfer procedures mentioned in the Impression Transfer section. “Cast-To” Gold Abutments for internal octagon [OPGA] or internal hexagon [SPGA] implants consist of an octagon or hexed, gold “Cast-to” abutment body an abutment screw [GPCAS or MHLAS] and a 3.8 mmD press-fit Plastic Sheath [OPS].

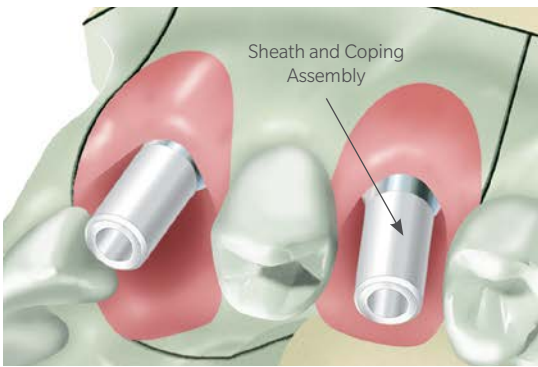

Attaching the Abutments and Plastic Sheaths

Carefully seat the assemblies onto the Implant Replicas in the working cast. Insert the abutment screws through the abutment assemblies and thread them into the Implant Replicas with the 1.25 mmD Hex Tool. To fully seat the abutments, tighten the abutment screws to 30 Ncm with a calibrated torque wrench.



Trimming the Plastic Sheaths

Visually determine the modifications needed to provide adequate clearance for adjacent and opposing dentition. Consult with the clinician to determine any additional modifications needed for the case design. The case illustrated here involves the fabrication of a cast abutment on the canine and a screw-retained, combination abutment-and-crown on the second premolar.

Section the Plastic Sheaths with a cutting disk to obtain the correct vertical and interproximal clearance.

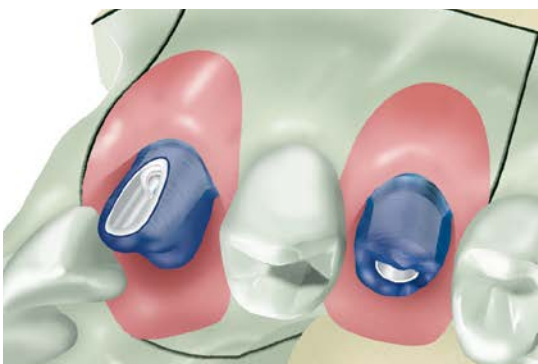

Fabricating the Framework Pattern

Use wax and/or acrylic burnout resin to incorporate the modified gold base and Plastic Sheaths into the pattern. Build up the final contours of the pattern with crown-and-bridge wax.

As an option to using the Plastic Sheaths and abutment screws:

- Secure the abutments to the Implant Replicas with the Waxing Screws [WSX for the 4.8 mmD internal octagon implants and MTWSD for 3.8 mmD internal hex implants].
- Lightly lubricate the Waxing Screw.
- Use wax and or acrylic burnout resin and fabricate the framework pattern around the screw and directly to the abutments.

Fabricating the Metal Frameworks

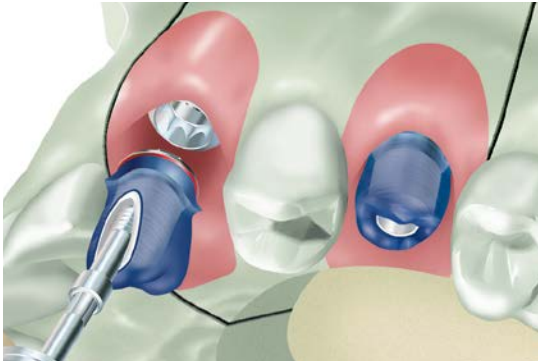

Removing the Framework Pattern

Remove the abutment screw with the 1.25 mmD Hex Tool. Gently remove the gold base with attached framework from the Implant Replica.

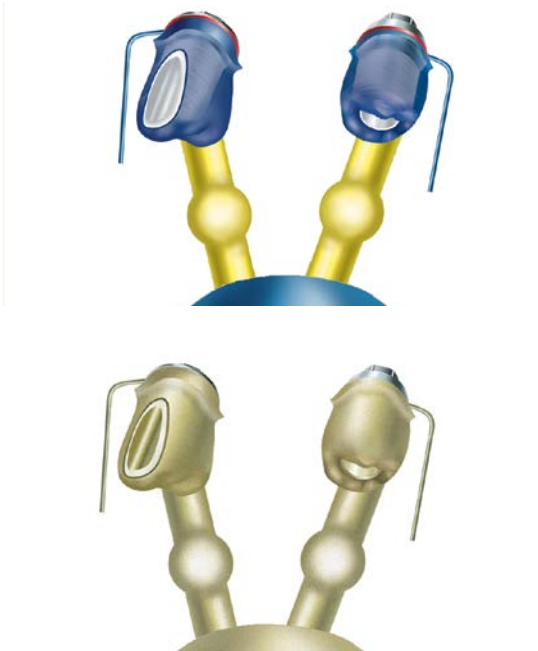

Spruing, Casting and Divesting of the Metal Framework

Attach 10-gauge sprue wax with reservoirs to the thickest part of each unit. Carefully apply a thin layer of wax or burnout resin at the junction of the abutment and the Plastic Sheath to ensure a smooth casting. Add auxiliary sprues and vents to prevent porosity in the casting, as needed.

Do not use a debubbler when investing the gold or plastic components. When casting to gold components, the casting alloy must not exceed a casting temperature of 2350°F/1288°C. Cast the framework pattern according to conventional techniques utilizing a two-stage burnout, which is standard practice with patterns containing plastic or resin. The burnout temperature should not exceed 1500°F/815°C, with a hold time of no longer than 1 hour. Utilize high noble or noble alloy with a compatible investment material, as described in the manufacturer’s guidelines.

Divest the casting, chemical investment removers may also be used with gold components. To ensure that the fitting surface of the incorporated copings are not damaged, protect the abutment interface while blasting the abutment with glass bead. Clean the casting in an ultrasonic unit.

Refine the screw access holes within the casting by hand-rotating a reamer for “Cast-To” Abutments.

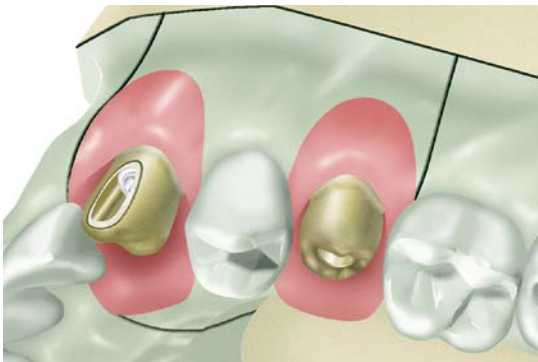

Finishing the Metal Framework

Confirm that a passive fit has been achieved on the corresponding Implant Replica in the working cast. The soft tissue replica can be removed from the working cast to provide visual access to the cast abutment/implant replica connection, if desired.

Use the abutment screws to secure the finished cast metal abutments to the implant replicas in the working cast and return it to the clinician for try-in.



GPCAS MHLAS

Caution: Make sure the clinician is aware that the screw for the OPGA is GPCAS and the screw for the SPGA is MHLAS and that they are significantly different.

Trying in the Metal Frameworks

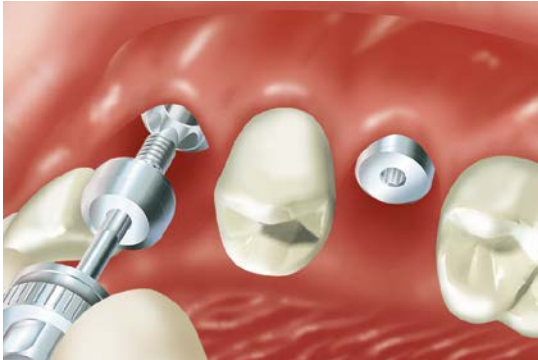

Removing the Healing Components

Unthread the abutment screws with the 1.25 mmD Hex Tool and remove the abutments from the working cast.

Sterilize the components according to standard clinical procedures. Remove the provisional restoration from the patient’s mouth. Unthread the Surgical Cover Screws with the 1.25 mmD Hex Tool. Clean and sterilize the components for placement after the cast abutment try-in.



Placing the Cast Abutments

Interdigitate each cast post with its corresponding implant. Insert the abutment screw through the cast post body and use the 1.25 mmD Hex Tool to thread the screw into the implant. Tighten the abutment screw to 30 Ncm with a calibrated torque wrench. Wait ten minutes, then retighten the cast posts to 30 Ncm. Take a radiograph to verify that the cast posts are completely seated.

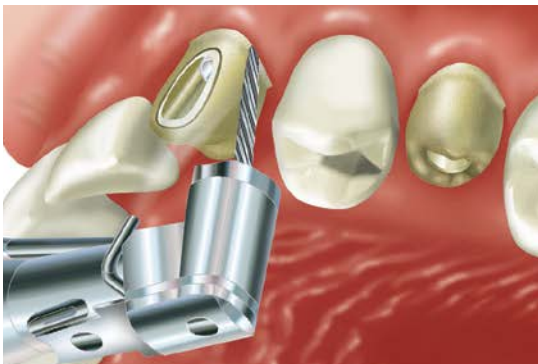

Making the Adjustments to the Cast Abutments

The premolar will be a screw-retained, combination post-and-porcelain-fused-to-metal crown. The canine will be a cast abutment with a porcelain-fused-to-metal crown cemented onto it. To make allowance for the different restorative procedures make the required modifications to the gingival, occlusal and interproximal contours of the cast abutments with a round-end diamond or 12-fluted carbide bur in a high-speed handpiece, and under copious irrigation.

Follow appropriate procedures for each type or restoration listed below.

Note that two options are available for restoring the cast abutment in the canine position.



Canine: Cemented Crown — Option 1

Make a crown and bridge impression of the seated cast post. Place the provisional fabricated by the laboratory or chairside on the cast abutment. Return the impression to the laboratory for the fabrication of a porcelain-fused-to-metal prosthesis according to routine laboratory procedures for crown and bridge.

Finishing the Metal Frameworks



Canine: Cemented Crown — Option 2

Unthread the abutment screw with the Hex Tool and remove the abutment post from the mouth.

Sterilize the cast post assembly according to standard clinical procedures and reseat it on the working cast. Select a tooth shade for the restoration, reseat the healing components with the 1.25 mmD Hex Tool and replace the provisional restoration in the patient’s mouth. Send the working cast with the cast post to the laboratory for fabrication of the final porcelain-fused-to-metal restoration. The laboratory can use the cast post as a die to fabricate the coping.

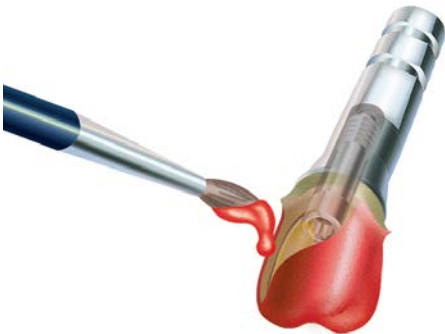

Canine: Cemented Crown — Option 2

Prepare the abutment for fabrication of a porcelain-fused-to-metal restoration. Seal the abutment screw access hole of the cast post with a resilient material. Lubricate the cast post and flow autopolymerizing burnout resin over the contour of the cast post above the proposed restoration finish line. Do not use crown and bridge wax directly on the cast post, as it can pull away from the metal and cause inaccuracies in the final metal coping.



Canine: Cemented Crown — Options 1 and 2

Build up the final contour of the coping with crown-and-bridge wax. Attach 10-gauge sprue wax to the thickest part of the coping.

Invest the coping:

- **Option 1:** Follow standard setting expansion of the investment material when using a stone die.
- **Option 2:** Allow for a greater setting expansion of the investment material when using a metal die (abutment). This will compensate for the lack of die spacer used on the abutment when the coping pattern was fabricated.

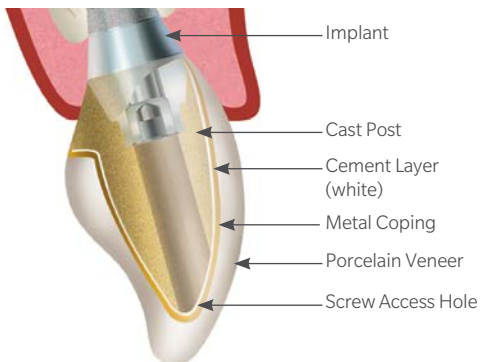

Canine: Cemented Crown — Options 1 and 2

Fabricate the porcelain-fused-to-metal crown according to routine laboratory procedures. The result will be a three-piece prosthesis consisting of a screw-retained post (2-piece) for the implant, and a porcelain-fused-to-metal crown that will be cemented onto the post.

Seating the Final Prostheses

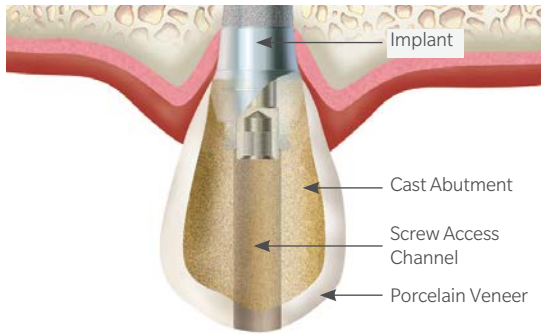

Premolar: Combination Abutment and Crown

Unthread the abutment screw with the 1.25 mmD Hex Tool and remove the abutment from the mouth. Sterilize the cast abutment assembly according to standard clinical procedures and reseat it on the working cast. Select a tooth shade for the restoration, reseat the healing component with the 1.25 mmD Hex Tool and replace the provisional restoration in the patient’s mouth.

Prepare the abutment removed from the premolar position for porcelain application. Follow routine laboratory procedures for a screw-retained, combination abutment-and-crown prosthesis.

Do not allow porcelain to enter the screw access channel of the prosthesis.

Canine and Premolar

Carefully polish the finished prostheses without damaging the machined interfaces or crown margins. Attach additional implant replicas to the prostheses prior to polishing.

Reseat the prostheses on the working cast and return them to the clinician for final delivery.

Delivering the Final Prostheses

Remove the prostheses and abutment from the working cast and sterilize them. Remove the provisional restorations and use the 1.25 mmD Hex Tool to remove the healing components.

Interdigitate the abutments with their corresponding implants. Insert the abutment screws through the abutment bodies and thread into the implants with the 1.25 mmD Hex Tool. Tighten the abutment screws to 30 Ncm with a calibrated torque wrench. Wait ten minutes, then retighten the screws. Take a radiograph to verify complete seating of the cast abutment and combined abutment-and-crown.

Premolar: Confirm the fit, contour and occlusion of the restoration, and make any needed final adjustments. Insert small cotton pellets or other resilient material into the screw access channel to ensure access to the screw head, then fill the channel with composite resin material to complete the contour and esthetics of the restoration.

Canine: Fill the screw access channel of the custom abutment post with cotton pellets to ensure access to the screw head, then fill the channel with a light-curing resilient material or gutta percha. Confirm the fit, contour and occlusion of the restoration, and make any needed final adjustments. Cement the final prosthesis with a cement of choice. To facilitate future retrievability, a soft-access cement may be used.

Provide the patient with oral hygiene instructions prior to release.

Tapered Abutment System

Restorative Options and Vertical Height Requirements for Tapered Abutments

Tapered Abutments provide an extension to the implant interface during the fabrication of partially or fully edentulous splinted screw-retained multiple-unit prostheses. Once connected to the implant they extend through the soft tissue to create a common screw receiving platform normally located 1 mm supra-gingival.



The Tapered Abutment is a one-piece titanium alloy component having a 5.2 mm outside diameter and a 4.5 mmD prosthetic platform. The raised central section has 15° tapered walls which requires implants to be within 30° of parallelism to each other for a splinted prosthesis to have a passive path of draw. Located within the raised area are the threads which receive the fixation screw [SCTS] for holding down the prosthesis. Below the internally threaded area of the abutment is a 1.25 mmD matrix (female) hex designed to receive the standard 1.25 mmD Hex Tool. Rotation of the Hex Tool to a calibrated 30 Ncm will fully seat the abutment sealing the abutment/implant interface. Each abutment is supplied with a protective cap [TATHC] to seal the abutment platform during prosthesis fabrication.

Tapered Abutments are available in two heights (1.6 mm and 3.0 mm), measured from the height of contour of the implant to the prosthetic interface. Once all the restorative components are in place, the minimum vertical clearance between the implant interface and the opposing dentition is 5.0 mmL (as shown below).

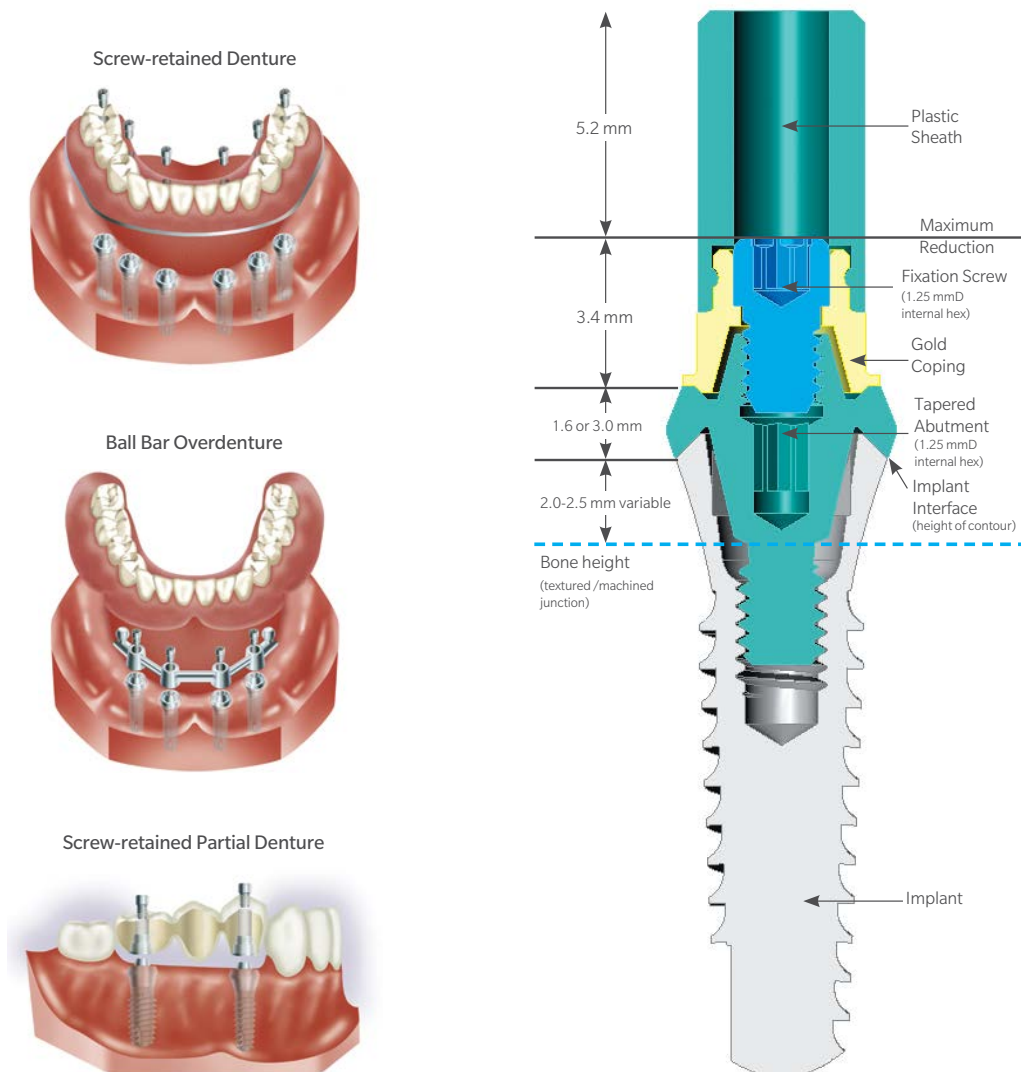

Components for Tapered Abutment System

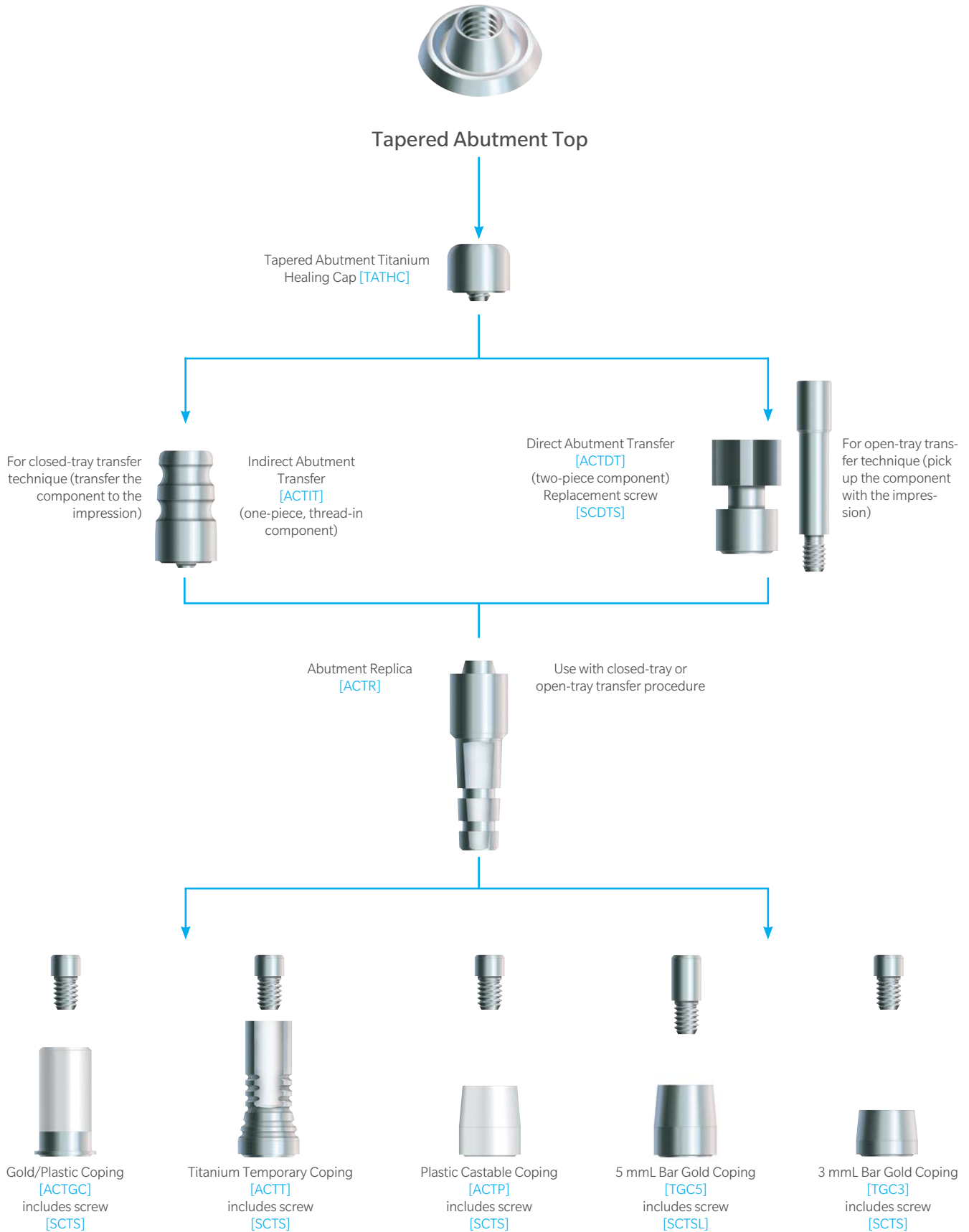

Tapered Abutment System to Fabricate a Ball Bar Overdenture

Fabricating a Custom Tray

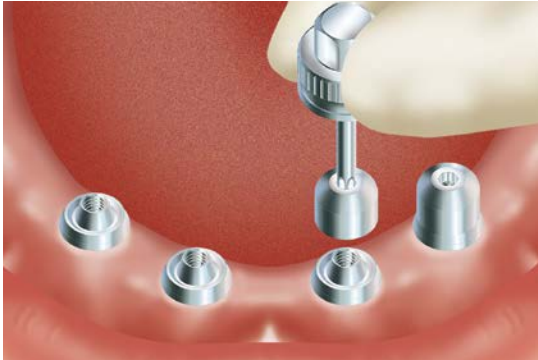

Fabricating the Custom Tray

Option 1: Open-Tray Procedure with Direct Transfers.

Attach the Tapered Abutments [OPACT or OPACT3] with the 1.25 mmD Hex Tool and tighten to 30 Ncm with a calibrated torque wrench. Thread Titanium Healing Caps [TATHC] into the abutments with the Hex Tool. Make a full arch impression of the Healing Caps and edentulous areas. Send it to the laboratory for fabrication of a working cast and custom impression tray.

Alternatively, select a stock tray and mold the border with a low fusing compound material. The patient's existing, modified denture can continue to be worn during the laboratory phase.

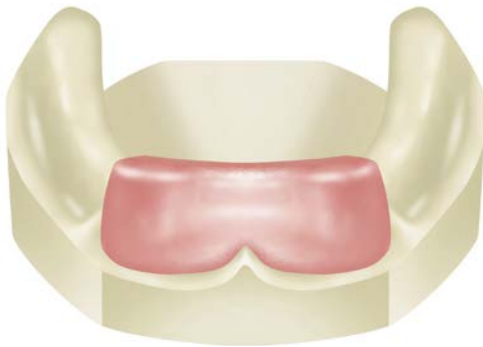

Fabricating the Custom Tray

Pour the impression in dental stone and separate the preliminary cast after it sets.

Block the area above the abutments with baseplate wax to simulate the position of the abutment transfers that will be used.

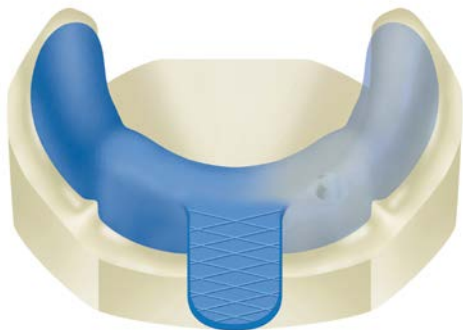

Fabricating the Custom Tray

Option 1: Open-tray procedure with Direct Transfers.

Fabricate the custom impression tray with autopolymerizing or light-cure tray resin. Create an opening above the abutment area to allow for access to the direct transfer screws.

Option 2: Closed-tray procedure with Indirect Transfers.

Fabricate the custom impression tray with autopolymerizing or light-cure tray resin and leave the area above the abutments closed.

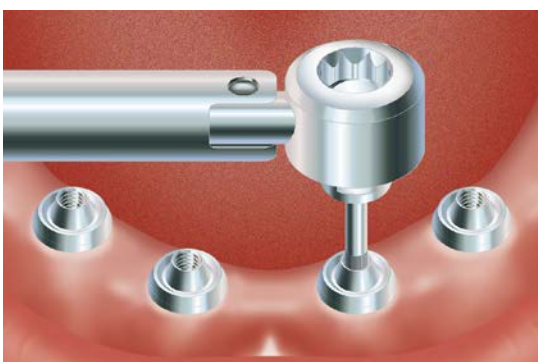

Making the Transfer Impression

Recall the patient when the custom tray is ready. Remove the Healing Caps with the 1.25 mmD Hex Tool. Retighten the Tapered Abutments to 30 Ncm with a calibrated torque wrench.

Making a Direct (Open-tray) Transfer

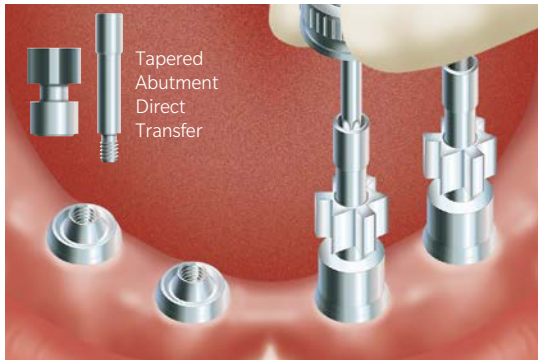

Option 1: Attaching the Direct Transfers

Place the body of the Tapered Abutment Direct Transfer [ACTDT] onto the top of the abutment. Insert the transfer screw through the transfer body, thread it into the abutment and finger-tighten with the 1.25 mmD Hex Tool. If needed, a replacement screw [SCDTS] for the Tapered Abutment Direct Transfer is available.

In areas of limited vertical height, the transfer screws can be shortened with a cutting disc prior to use. During the impression procedure, the Tapered Abutment Direct Transfer bodies will be picked up by the impression material.

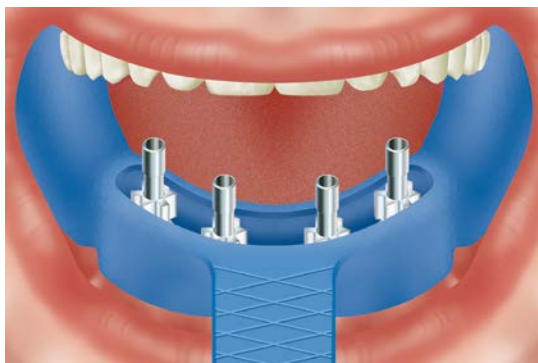
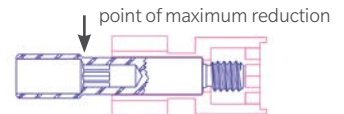

Option 1: Verifying Fit of the Custom Tray

Place the open-access tray over the assembled Direct Transfers in the patient's mouth to verify that the screws penetrate through the top of the tray without hindrance. Remove the open-access tray and place a softened piece of baseplate wax on the top of the tray to cover the access opening. This will help contain the impression material. Try in the tray and allow the screws to create access holes through the wax. Remove the tray from the mouth, chill in water, dry, then apply adhesive. Block out the hex-holes in the tops of the screws with material of choice to prevent the ingress of impression material.

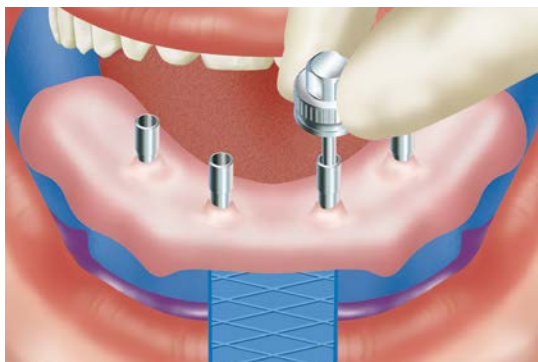

Option 1: Making the Impression

An elastomeric impression material is recommended, such as vinyl polysiloxane. Inject light body impression material around the Direct Transfers and fill the open-access tray with heavier body impression material. Place the loaded tray into the patient's mouth and allow the screws to penetrate through their respective access holes in the hardened baseplate wax. Remove excess impression material from the tops of the screws and allow the impression material to set according to the manufacturer's recommendations. Unthread the screws from the transfers with the Hex Tool and remove them from the patient's mouth. Remove the tray from the mouth. Replace the Healing Caps. The Direct Transfer bodies will be retained in the impression material.

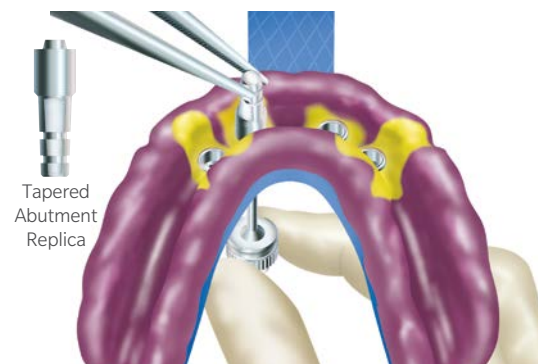

Option 1: Completing the Transfer Procedure

Stabilize the Tapered Abutment Replica [ACTR] with forceps to prevent rotation and insert the screw-receiving end of the replica into the base of the transfer body within the impression material.

Attach the transfer screw to the Hex Tool, and insert it through the respective access hole in the back of the impression tray. Pass the screw through the embedded transfer body and thread it into the attached replica to lock the components together.

Make an opposing arch impression. Send all the materials to the laboratory for fabrication of a stabilized baseplate with occlusal registration rim.

Making an Indirect (Closed-tray) Transfer

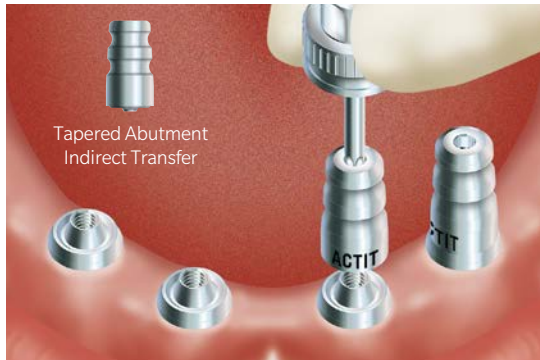

Option 2: Attaching the Indirect Transfers

Thread the Tapered Abutment Indirect Transfers [ACTIT] into the tops of the Tapered Abutments with the Hex Tool and finger-tighten.



Option 2: Making the impression

Block out the hex-holes in the tops of the transfers with material of choice to prevent the ingress of impression material. An elastomeric impression material is recommended, such as vinyl polysiloxane. Inject light body impression material around the Indirect Transfers and fill the closed tray with heavier body impression material. Make a full-arch impression, and allow the material to set according to the manufacturer's recommendations before removing. Unthread the Indirect Transfers from the Tapered Abutments with the Hex Tool and set them aside.

Use the 1.25 mmD Hex Tool to replace the Healing Caps.

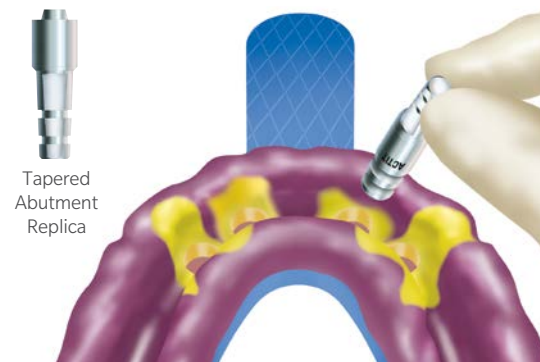

Option 2: Completing the Transfer Procedure

Thread the transfer onto the Tapered Abutment Replica [ACTR] and finger-tighten with the Hex Tool.

Insert the replica/transfer assembly into the impression hole. A double-click indicates that the transfers are fully seated. Make an opposing arch impression. Send all the materials to the laboratory for the fabrication of a stabilized baseplate with occlusal registration rim.



Fabricating the Verification Jig

Pour the impression in die stone. To separate the cast from the impression:

- Open-tray Impression: First unthread and remove the transfer screws with the Hex Tool. Remove the tray from the cast.
- Closed-tray Impression: Remove the tray from the cast. Unthread and remove the transfer bodies from the cast with the Hex Tool.

Gold Copings [ACTGC] will be used to fabricate a stabilized baseplate and occlusal registration rim. These components consist of the metal coping, fixation screw [SCTS] and 3.8 mmD press-fit Plastic Sheath [OPS].

Attach the cylinders to the abutment replicas with Waxing Screws [SCWS] to maintain access. Set the coping fixation screws and Plastic Sheaths aside for later use.

Fabricating a Verification Jig and Occlusal Rims

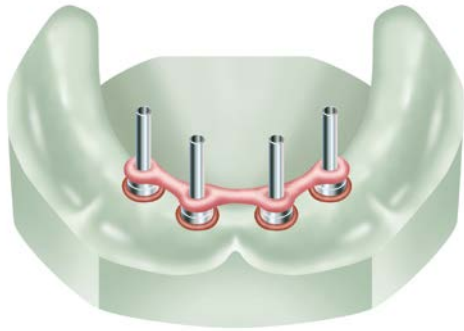

Fabricating a Verification Jig

Block out undercuts beneath the copings with baseplate wax. Lubricate the working cast. Lute the copings together with autopolymerizing or light-cure resin. To prevent distortion from contraction, section the pattern between the copings with a thin separating disk, then relute the sections together. To confirm a passive fit, remove the waxing screws from the pattern and reattach the framework pattern to the most distal abutment replica with a single screw and finger-tighten with the Hex Tool. Verify that the remaining copings within the framework pattern rest passively on the abutment replicas. Send the resin framework pattern to the dentist with the coping fixation screws for patient try-in. A passive fit will confirm that an accurate transfer has been achieved.

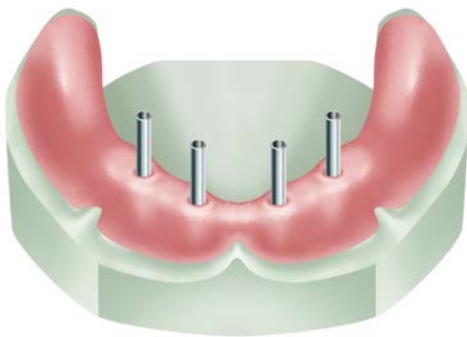

Fabricating a Stabilized Baseplate/Occlusal Rim

After the patient try-in, use the Hex Tool to replace the coping fixation screws with the longer Tapered Abutment Waxing Screws [SCWS]. Position a sheet of light-curing baseplate material over the tops of the assembled waxing screws and framework pattern. Gently press the modified sheet onto the working cast and allow the screws to penetrate the material. Form the material around the framework and to the contours of the edentulous arch to fabricate a stabilized baseplate.

Create a wax occlusal registration rim on the stabilized baseplate. Send the assembly to the dentist for interocclusal records.

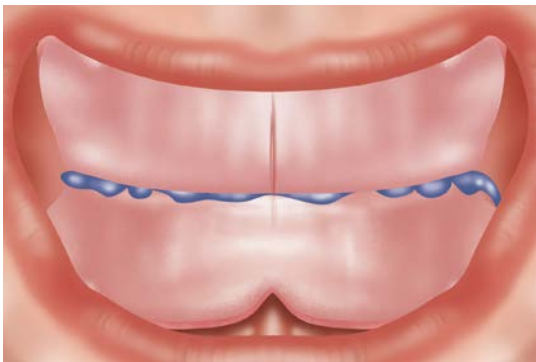

Making an Interocclusal Record

Remove the Healing Caps [TATHC] from the abutments in the patient's mouth with the Hex Tool. Attach the baseplate and occlusal rim assembly to the abutments with the fixation screws and gently finger-tighten with the Hex Tool.

Contour the wax occlusal rim and mark the midline and smile line. Make a bite registration at the vertical dimension of occlusion. Remove the baseplate and bite registration from the patient's mouth and reassemble it on the working cast with the fixation screws. Reattach the Healing Caps to the abutments. Select the prosthetic teeth and send the materials to the laboratory for fabrication of a stabilized denture wax try-in.



Fabricating a Stabilized Denture Wax Try-in

Mount the working and opposing arch casts on an articulator.

Set up the denture teeth on the stabilized baseplate. At this point, access to some of the copings will be covered up with denture teeth. Do not create access holes through the denture teeth. Two copings lingual to the anterior teeth will sufficiently stabilize the wax-up for patient try-in. Send the stabilized denture wax-up to the dentist for a patient try-in.

Fabricating a Matrix and Framework Pattern



Patient Try-In

Remove the Healing Caps from the abutments in the patient's mouth with the Hex Tool. Torque the abutments to 30 Ncm with a calibrated torque wrench. Place the try-in onto the abutments. Attach the fixation screws through the access holes in the wax-up and gently finger-tighten (**NOTE:** some of the copings will be covered by the denture teeth). Make necessary adjustments and obtain patient approval. Remove the denture wax try-in from the patient's mouth and replace the Healing Caps on the abutments. Use the Hex Tool to secure the stabilized baseplate wax-up on the abutment replicas in the working cast with the fixation screws and return it to the laboratory for fabrication of the metal framework.

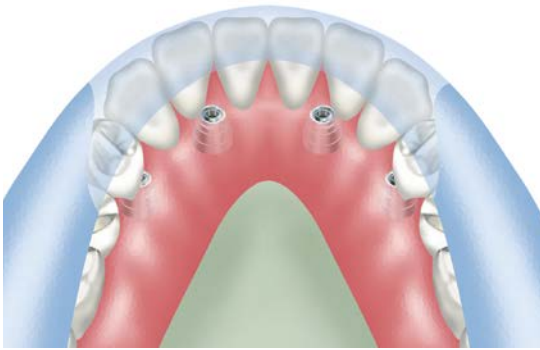

Fabricating the Framework Pattern

Fabricate a silicone or plaster labial/occlusal matrix to record tooth position and the labial borders of the prosthesis relative to the working cast.

An alternate procedure for immediate framework fabrication would be to attach Bar Gold Copings [TGC3 or TGC5] to the replicas. Splint the copings with gold bars using an autopolymerizing acrylic. Invest, solder and finish the framework via standard procedures.

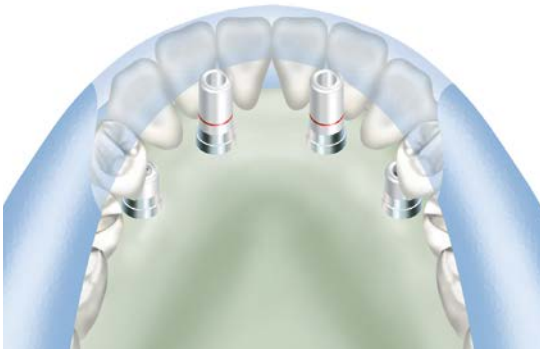

Remove the teeth from the denture wax try-in, place them back into their respective locations in the matrix and lute them into position with sticky wax. Retrieve the gold copings from the baseplate and retain them on the abutment replicas with the fixation screws. Press the plastic burn-out sheaths [OPS] onto the copings. Place the matrix with the attached teeth back onto the working cast to guide shortening of the plastic sheaths and design of the framework. Section the Plastic Sheaths with a cutting disk to provide adequate clearance for the teeth suspended in the matrix. Instead of using the Plastic Sheaths and fixation screws, the framework pattern can be waxed directly to the copings and around the Waxing Screws [SCWS].

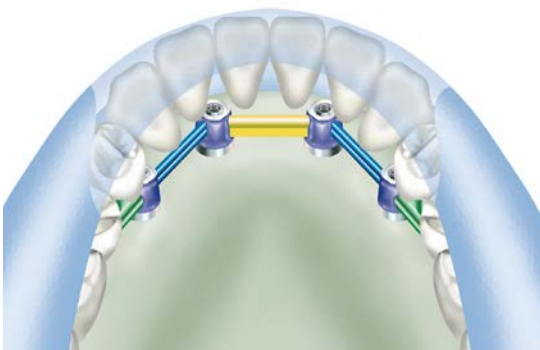

Incorporate the gold/plastic combination [ACTGC] into a bar overdenture design using preformed patterns. Use the mandril from the Cap Attachment Instruments [CAI] in a surveyor to incorporate castable ball patterns from the Cap Attachment System [CAS] into the distal ends of the bar pattern, avoiding excessive cantilevers.

Use the teeth suspended in the matrix as a guide to provide adequate clearance for the attachments, teeth and the denture base thickness. The ball patterns are the same 2.5 mm diameter as the machined titanium Ball Abutments and accept the standard Cap Attachments [CA].

Fabricating the Metal Framework

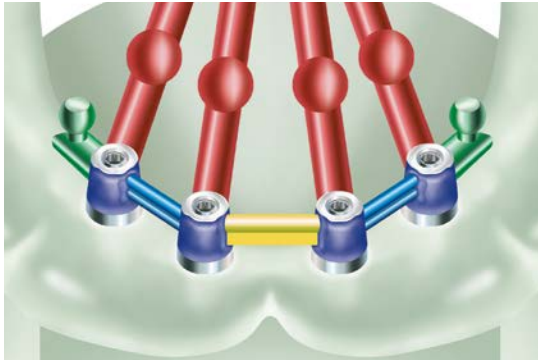

Spruing the Framework Pattern

Sprue the bar pattern with 10-gauge sprue wax with reservoirs. Invest the framework pattern with a high-heat, phosphate-bonded investment material following the manufacturer's instructions. Do not use a debubbler when investing the gold or plastic components. A two-stage burn-out is recommended when using any type of acrylic burn-out resin or large volume of wax. The burnout temperature should not exceed 1500°F (815°C), with a hold time of no longer than 1 hour. Cast the framework in a high noble or noble alloy exhibiting a high tensile strength. The casting temperature of the alloy must not exceed 2350°F (1288°C). After casting, the ring should be allowed to bench cool. Do not quench.



Divesting and Finishing the Metal Framework

To ensure that the fitting surface of the incorporated copings are not damaged, divest the casting, blast it with glass bead while protecting the coping interface, then clean the casting in an ultrasonic unit. Refine the screw access holes within the casting by rotating a reamer for Tapered Abutment Copings by hand. Confirm that a passive fit has been achieved. Send the assembly to the dentist for try-in of the metal framework to verify the passive fit.



Patient Try-in

Remove the Healing Caps from the abutments in the patient's mouth with the 1.25 mmD Hex Tool. Retighten the abutments to 30 Ncm with a calibrated torque wrench. Seat the metal framework on the abutments. Beginning with one of the distal abutments, thread in the fixation screw and finger-tighten with the Hex Tool. If the framework lifts off the other abutments when the screw is tightened, the framework is not fitting passively. Determine where the framework should be sectioned and mark the location on the framework with a felt-tipped pen. Remove the framework and replace the Healing Caps. If a passive fit was achieved, attach the remaining screws and tighten to 20 Ncm with a calibrated torque wrench.



Correcting the Framework for a Passive Fit

Remove the framework from the patient's mouth. Use a very thin separating disk and a high speed handpiece to section the framework diagonally to its occlusal surface for maximum strength after reconnection. Take care not to section in areas that have been designated for attachment placement. Incorrect sectioning of the framework may cause a weak solder joint, which will compromise the strength of the final prosthesis.

Correcting the Framework Fit

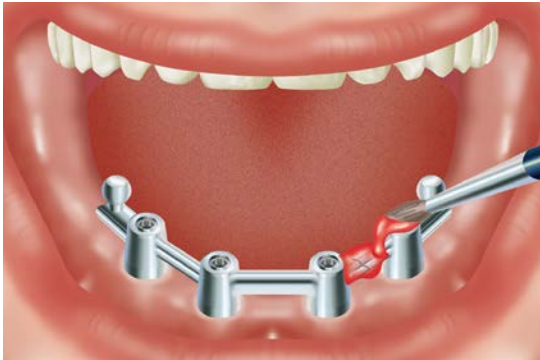

Correcting the Framework for a Passive Fit

Remove the Healing Caps from the abutments with the Hex Tool. Tighten the abutments to 30 Ncm with a calibrated torque wrench. Attach the framework sections to the abutments with the fixation screws and tighten to 20 Ncm with the torque wrench. Apply fast-setting autopolymerizing resin to the sectioned areas. The resin will flow into the joint via capillary action. Apply additional resin to form a callous that encapsulates reinforcement across the sectioned area to strengthen the connection. After the resin has fully set, remove the reassembled framework. Do not reattach the luted framework to the working cast. Replace the Healing Caps on the patient's abutments and send the unattached, luted framework and working cast to the laboratory.

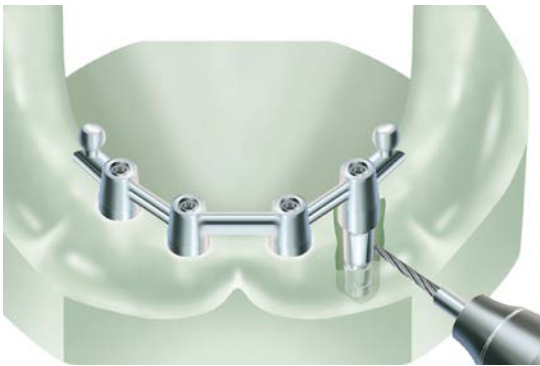

Correcting the Framework for a Passive Fit

Follow standard laboratory procedures to invest, solder and finish the framework. Return the soldered framework and fixation screws to the dentist to verify that a passive fit has been achieved. Once a passive fit has been verified, the working cast must be adjusted to accommodate the soldered framework. Use a fissure bur to remove the misaligned abutment replicas from the working cast one at a time until the framework rests passively. Attach the removed replicas to the framework at the appropriate locations, then attach the framework to the remaining replicas in the working cast with the fixation screws. Soak the working cast in water, then carefully vibrate stone into the voids and around the retentive features of the replicas.

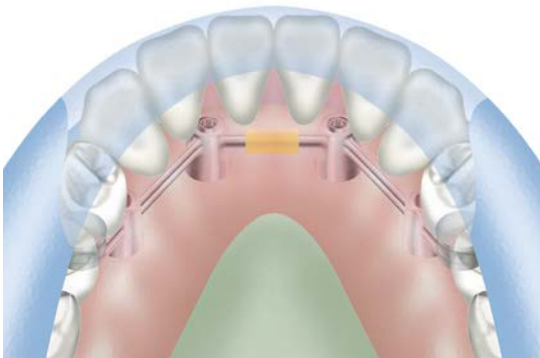

Fabricating a Final Stabilized Denture Wax Try-in

Snap the yellow Cap Attachment Transfers [CAT] onto the distal ball components. Place the metal housings [CAH] onto the Cap Attachment Transfers. Align the metal housings for a common path of draw. Snap a bar processing clip onto the anterior bar segment. Block out undercuts then process a light-cure denture base that incorporates the attachments. Using the silicone index or matrix as a guide, lute the prosthetic teeth to the denture base with baseplate wax. To prevent fracture of the light-cure baseplate, place the yellow Cap Attachment Transfers on the Bar Ball components for the stabilized tooth try-in. Send the denture wax-up and metal framework to the dentist for try-in and final approval prior to final processing.



Patient Try-in

Remove the Healing Caps from the abutments with the Hex Tool. Torque the abutments to 30 Ncm with the torque wrench and Hex Tool. Seat the metal framework onto the abutments, thread in the fixation screws with the Hex Tool and tighten to 20 Ncm with the torque wrench. Snap the yellow Cap Attachment Transfers onto the ball components of the metal framework. Place the denture wax try-in into the patient's mouth and allow the yellow transfers to insert into the metal housings in the baseplate. Verify that the anterior clip attaches to the bar. Evaluate and validate esthetics and phonetics. Place the set-up, metal framework and Cap Attachment Transfers back onto the working cast, and return them to the laboratory for final processing. Replace the Healing Caps onto the abutments in the patient's mouth.

Seating the Final Prosthesis



Processing the Final Prosthesis

Process the denture with the appropriate attachments: In the anterior, utilize a processing clip from a bar attachment system. In the posterior, snap yellow Cap Attachment Transfers [CAT] onto the ball components. Place the Cap Attachment Housings [CAH] from the Cap Attachment System [CAS] onto the transfers. Align the metal housings for a common path of draw and then block out the undercuts beneath the metal housings with appropriate block-out material. Process the denture according to conventional laboratory procedures.

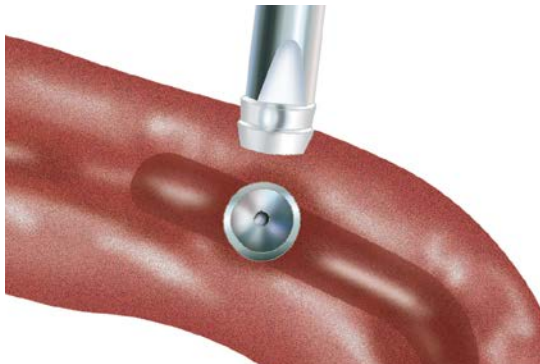

Processing the Cap Attachments

When the processed denture returns from the laboratory, remove the Healing Caps from the abutments in the patient's mouth with the Hex Tool. Tighten the abutments to 30 Ncm with a calibrated torque wrench. Seat the metal framework on the abutments, thread in the fixation screws with the Hex Tool and tighten to 20 Ncm with a calibrated torque wrench.

Place one nylon liner [CAN] from the Cap Attachment System [CAS] onto the end of the Insertion Tool from the Cap Attachment Instruments [CAI]. Press the nylon liner into one of the metal housings in the denture base.



Processing the Cap Attachments

Check the retention of the liner by snapping the denture on and off the Ball Bar in the patient's mouth. If necessary, decrease the retention of the nylon liner by inserting the Reaming Tool from the Cap Attachment Instruments [CAI] into the nylon liner and rotating in a clockwise direction to reduce the retention of the liner's walls. When adequate retention has been achieved, process the second liner in the same manner. Process only one nylon liner at a time.



Seating the Final Prosthesis

Insert the finished prosthesis into the patient's mouth and snap the incorporated attachments onto the Ball Bar. Make final adjustments to the occlusion. Instruct the patient in the use and care of the prosthesis, and provide oral hygiene instructions. Caution the patient not to use bleach on the prosthesis, which can damage the Cap Attachment nylon liners, and to insert/remove the overdenture by using vertical forces instead of twisting or lateral forces. Proper care will prolong the use of the nylon liners. If the nylon liners lose retention, they can be easily replaced at a recall appointment. For patients who require stronger Cap Attachment retention, a gray Cap Attachment liner [CAN-G] with greater retention is also available.

Ball Abutment System

Restorative Options with Ball Abutments

Ball Abutments are used in attachment-retained, tissue-supported restorations where the patient is fully edentulous in the arch to be restored. The extra-coronal type of attachment mechanism consists of a one-piece abutment with a superior ball projection secured to the implant. A metal housing [CAH] and retentive nylon liner [CAN] mechanically retained within the metal housing collectively referred to as the Cap Attachment [CA], is fixed within the patient's denture. The inner receptacle of the nylon liner acts as the 360 degree universal rotational connection between the denture and the abutment/implant assembly and allows for only slight compressive vertical movement. These abutments can be processed into the denture either in a chairside pick-up technique or a laboratory technique. Both techniques will be discussed in this section.



This type of restoration requires sufficient depth of the posterior vestibule to protect the abutment/implant assembly from excessive lateral/horizontal force during mastication (Fig 10a-c). It is recommended to use implants with a length in excess of 12 mm and abutment heights should be kept to a minimum to maintain an acceptable implant/abutment height ratio. Therefore single arch fully edentulous patients with excessive resorption of the edentulous ridge might not be candidates for a restoration inclusive of this type of abutment system.

In most cases the restoration is done utilizing two implants with corresponding Ball Abutments placed in the canine area creating a fulcrum around which the attached denture will rotate (Fig. 10d). Absolute parallelism is not a prerequisite for success as the rotational aspect of the Cap Attachment on the ball component allows for adjustment of up to 28 degrees of relative divergence between implants. It should be noted that the long term stability and maintenance of the retentive connection is reliant on three dimensional alignment of the abutments and Cap Attachments (as shown below, Fig. 10e-10f) for increased longevity and success:

- 1) The implants should be placed anterior/posteriorly so that the fulcrum line through the center of the components is parallel to the mandibular hinge axis (Fig. 10e).
- 2) The implants should be placed vertically so that the tops of the metal housings are parallel to the occlusal plane of the patient's denture and corresponding opposing arch (Fig. 10f).
- 3) The implants should be parallel to each other along their long axis and perpendicular to the plane of occlusion to be in optimum position (Fig. 10g).



Fig. 10a



Fig. 10b



Fig. 10c

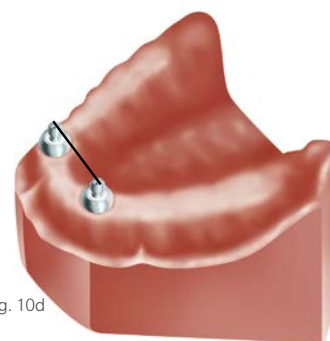

Fig. 10d



Fig. 10e

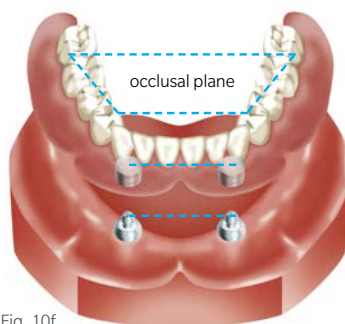

Fig. 10f

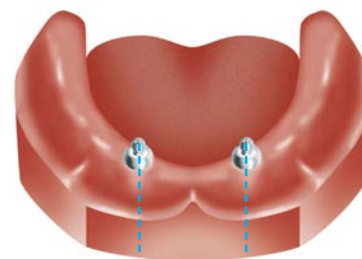

Fig. 10g

Vertical Height Requirements for Ball Abutments

Ball Abutment for Tapered SwissPlus Implant Systems

Ball Abutments are manufactured from titanium alloy and come packaged with the stainless steel Cap Attachment Housing [CAH] and Cap Attachment Nylon Liner [CAN]. The abutments for the Tapered SwissPlus 4.8 mmD platform implants are available in two collar heights (1.6 mmL, 3 mmL), measurement taken from the height of contour of the implant.

The Ball Abutment is attached to the Tapered SwissPlus implant which has its prosthetic platform normally placed 1 mm supra-gingival and has a coronal diameter of 5.2 mm while the ball component itself is 2.5 mmD. When assembled the vertical height of the Cap Attachment [CA] above the coronal aspect of the Ball Abutment is 4.0 mm and its diameter is 5.0 mm. Care should be taken to ensure sufficient denture acrylic surrounds the housing to prevent it from perforating the denture during function.

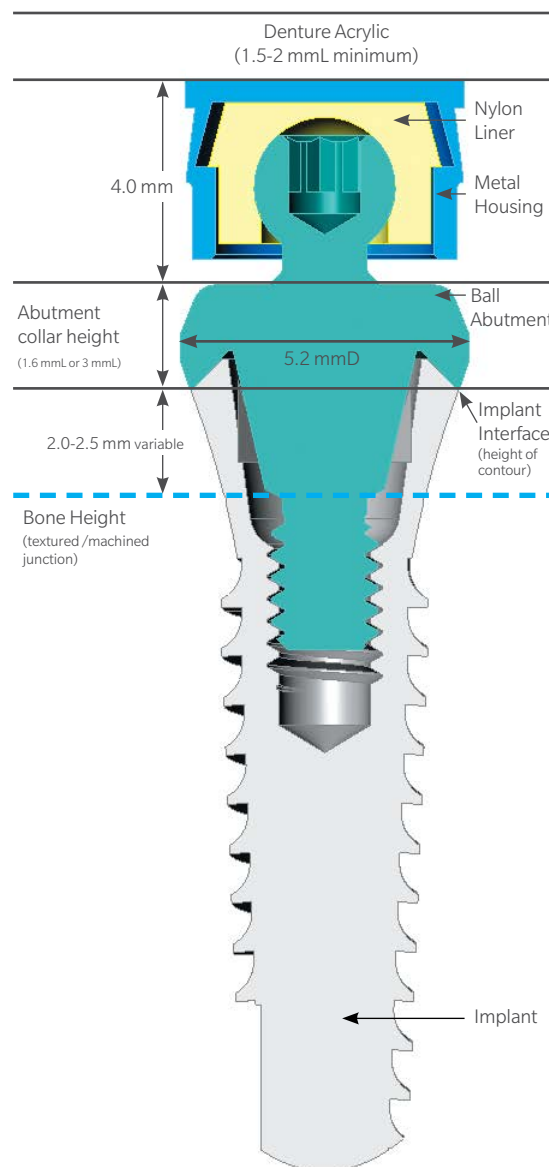

Tapered SwissPlus
Tissue-Level Implant

Components for Ball Abutment System

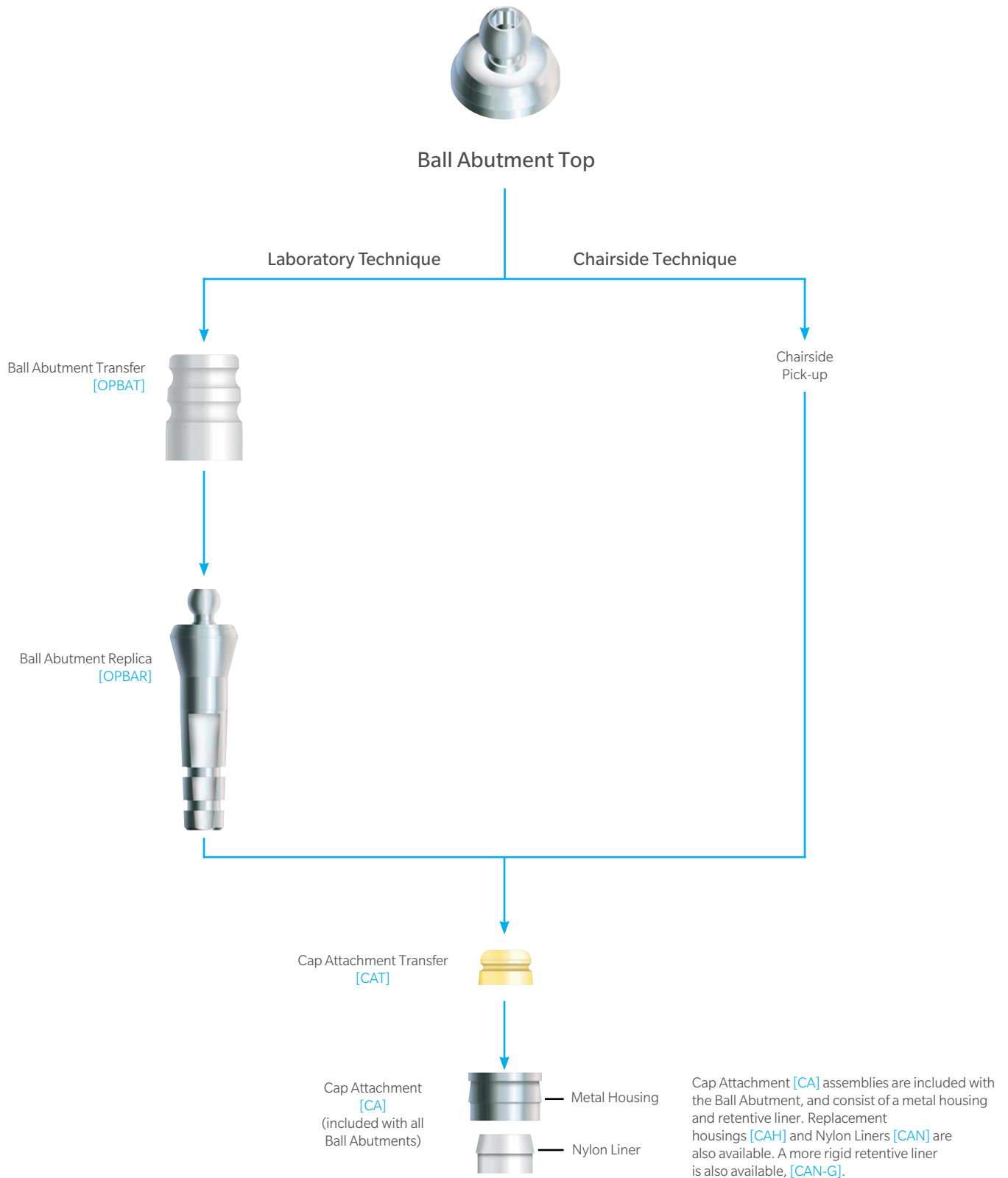

Laboratory Technique / Fabricating and Utilizing a Custom Tray

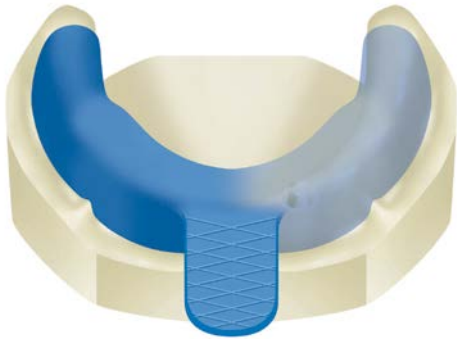

Fabricating a Custom Tray

Prior to attaching the abutments, make a full arch, alginate impression of the Surgical Cover Screws and edentulous areas. Send the impression to the laboratory for fabrication of a working cast and an impression tray with a spacer to accommodate the Ball Abutment Transfers. Fabricate the custom tray with light-cured or autopolymerizing tray material. The patient's existing, modified overdenture can continue to be worn during the laboratory phase. Alternatively, select a stock tray to provide access for the transfers, and mold the border with a low fusing compound material.



Attaching the Ball Components

Recall the patient when the custom tray is ready. Remove the Surgical Cover Screws with the 1.25 mmD Hex Tool. Select Ball Abutment components according to the transmucosal height requirements. Place the selected Ball Abutments into the implants and tighten to 30 Ncm with a calibrated torque wrench.



Seating the Transfers

Press the Ball Abutment Transfers [OPBAT] onto the Ball Abutments. The transfer will engage the outer portion of the abutment beneath the ball for maximum stabilization. An elastomeric impression material is recommended, such as vinyl polysiloxane. Inject light body impression material around the Ball Abutments and fill the impression tray with heavier body impression material. Place the loaded tray into the patient's mouth and allow the impression material to set according to the manufacturer's recommendations. Remove the impression from the mouth.

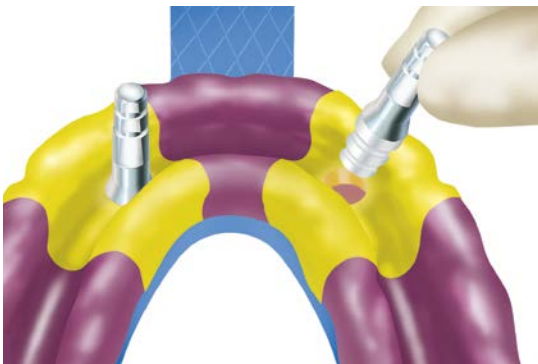

Completing the Transfer Procedure

Remove the Ball Abutment Transfers from the Ball Abutments, press them onto the Ball Abutment Replicas [OPBAR], and insert them back into the impression holes. A double-click indicates that the transfers are fully seated. Make an opposing arch impression. Send all the materials to the laboratory for fabrication of a stabilized baseplate with occlusal registration rim.

Laboratory Technique / Fabricating a Stabilized Baseplate and Bite Rim

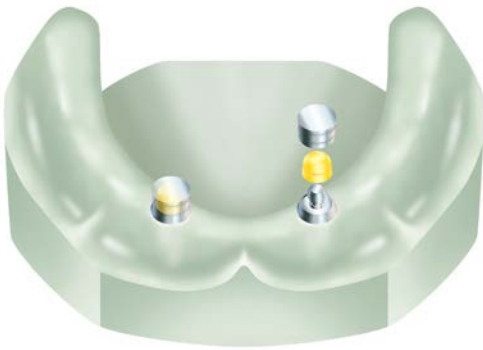

Fabricating a Stabilized Baseplate and Bite Rim

Pour the impression in die stone. Remove the tray from the cast and the Ball Abutment Transfers from the Ball Abutment Replicas now incorporated within the working cast.

Press-fit the yellow Cap Attachment Transfers [CAT] onto the Ball Abutment Replicas in the working cast. Place the Cap Attachment Housings [CAH] (included with the Ball Abutments) onto the Cap Attachment Transfers.



Fabricating a Stabilized Baseplate and Bite Rim

Rotate the assembled housings and transfers up to 28° to create relative parallelism for a common path of draw. Block out the undercuts beneath the housing assemblies with an appropriate silicone or wax material.



Incorporating the Housings into the Baseplate

Place gel viscosity light-cure resin material on the metal housings and cure. Incorporate the housings into a stabilized baseplate made from light-cured baseplate resin. Create a wax occlusion registration rim on the stabilized baseplate. Place the assembly on the working cast and send it to the dentist for fabrication of a stabilized bite registration.



Making a Stabilized Bite Registration

Snap the yellow Cap Attachment Transfers onto the Ball Abutments in the patient's mouth. Place the stabilized baseplate and occlusion registration rim into the patient's mouth and allow the transfers to insert into the metal housings in the baseplate. Make a bite registration with the stabilized baseplate and occlusion rim. Send the assembly to the laboratory for fabrication of a stabilized denture wax try-in.

Laboratory Technique / Delivering the Final Prosthesis



Making a Stabilized Denture Wax Try-in

After the laboratory fabricates a stabilized denture wax-up, recall the patient for try-in. Snap the yellow Cap Attachment Transfers onto the Ball Abutments in the patient's mouth. Place the denture wax try-in into the patient's mouth and allow the transfers to insert into the metal housings in the baseplate. Evaluate esthetics and phonetics, and verify that the wax-up fits passively. If changes in tooth position are prescribed, schedule additional try-in appointments until acceptable tooth arrangement is verified and approved by dentist and the patient. Place the approved stabilized denture wax try-in on the working cast with the Cap Attachment Transfers and send it to the laboratory for final processing.

Cap Attachment Instruments [CAI]



Nylon Liner Insertion Tool



Nylon Liner Reaming Tool



Mandril for Castable Ball Pattern

Cap Attachment Instruments

- Nylon Liner Insertion Tool: Used to carry and assist in the insertion of the Nylon Liner into the metal housing.
- Reaming tool: When the Nylon Liner is too retentive for the respective patient, the Reaming Tool is inserted into the liner and rotated in a clockwise direction. This action reduces the amount of retention between the ball component and the Cap Attachment by reducing the dimension of the liner's inner walls. Care should be taken to do this in small increments so as not to eliminate the required retention levels of the Nylon Liner.
- Paralleling Mandril: Used by the technician in combination with a surveyor to align the castable ball patterns in the correct position when fabricating a Ball Bar Overdenture.



Processing the Final Prosthesis

When the processed denture returns from the laboratory, retighten the Ball Abutments to 30 Ncm with a calibrated torque wrench. Place one Nylon Liner [CAN] from the Cap Attachments [CA] onto the end of the insertion tool. Use the Insertion Tool to press the Nylon Liner into one of the metal housings in the denture base. Check the retention of the liner by snapping the denture on and off the ball component in the patient's mouth.

If necessary, use the reaming tool to decrease the retention of the nylon liner. When adequate retention has been achieved, process the second nylon liner in the same manner. Insert and adjust only one Nylon Liner at a time.



Delivering the Final Prosthesis

Insert the finished prosthesis into the patient's mouth and snap the incorporated Cap Attachments onto the Ball Abutments. Make final adjustments to the occlusion. Instruct the patient in the use and care of the prosthesis, and provide oral hygiene instructions. Caution the patient not to use bleach on the prosthesis, which can damage the nylon Cap Attachment liners. To prolong the use of the nylon liners, instruct the patient to insert and remove the overdenture by lifting the prosthesis vertically instead of laterally or by twisting. If the Nylon Liners lose retention, they can be easily replaced at a recall appointment. For patients who require stronger Cap Attachment retention, gray Nylon Liners [CAN-G] with a more rigid retention are also available.

Chairside Technique / Adding Cap Attachments to an Existing Denture



Attaching the Ball Components

Remove the Surgical Cover Screws with the 1.25 mmD Hex Tool. Select Ball Abutment Components according to the transmucosal height requirements. Place the selected ball components into the implants and tighten to 30 Ncm with a calibrated torque wrench.

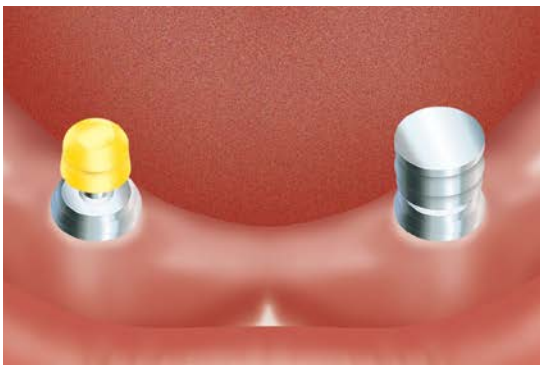

Preparing the Housings for Pick-up

Snap the yellow Cap Attachment Transfers [CAT] onto the Ball Abutments. Place the Cap Attachment stainless steel housings [CAH] over the transfers.

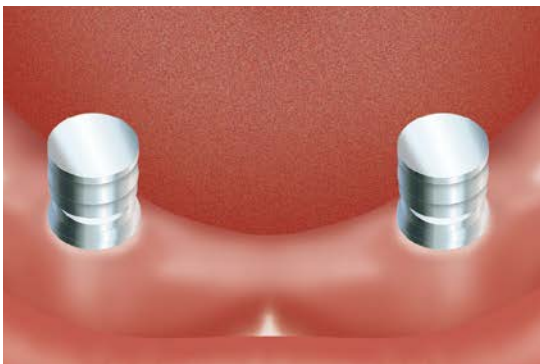

Preparing the Housings for Pick-up

Rotate the assembled Cap Attachment Transfers [CAT] and metal housings [CAH] on the Ball Abutments up to 28° to create relative parallelism for a common path of draw. Try and ensure that the components are aligned taking into consideration the occlusal plane of the denture, this will help with the smooth rotation of the denture around the Ball Abutment.

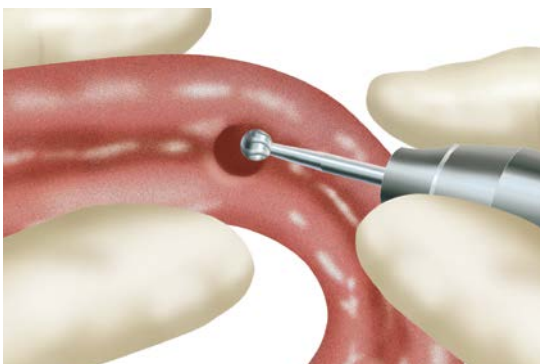

Preparing the Denture for Pick-up

Seat the denture into the patient's mouth to determine the locations of the metal housings relative to the tissue-bearing surface of the prosthesis. Remove the denture from the patient's mouth and mark the locations of the assembled housings on the bottom of the prosthesis. Relieve the areas over the housings with an acrylic bur until the denture can be fully seated in the patient's mouth without contacting the metal housings.

Small relief holes can be drilled through the top of the recess to allow excess acrylic to exude through.

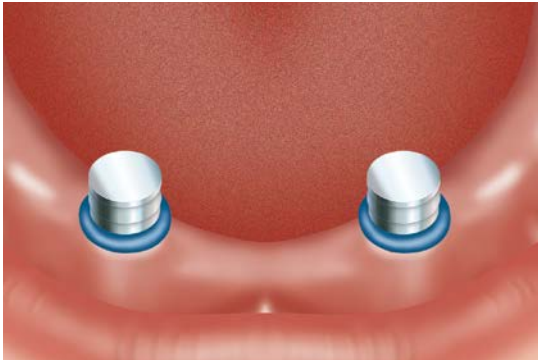

Preparing the Housings for Pick-up

Block out the undercuts beneath the housing assemblies with an appropriate silicone or wax material, taking care not to change the orientation of the housings on the Ball Abutment.



Processing the Housings into the Denture Base

Autopolymerizing acrylic is recommended for the pick-up. It flows better than a light-cured resin and engages the undercuts on the outside of the metal housings [CAH] more efficiently. Place a small amount of autopolymerizing acrylic into the dry, relieved areas within the denture base. Also place a small amount of acrylic directly on the tops of the housings. Place the denture over the housings in the mouth and instruct the patient to bite lightly in centric occlusion.

Remove the denture after the acrylic sets. Fill in any voids remaining around the processed housings with additional autopolymerizing acrylic.



Processing the Nylon Liners into the Denture Base

Remove the yellow Cap Attachment Transfers from the Ball Abutments in the patient's mouth. Place one Nylon Liner [CAN] from the Cap Attachments [CA] onto the end of the insertion tool from the Cap Attachment Instruments [CAI]. Press a Nylon Liner into the metal housing in the denture base. Check the retention of the liner by snapping the denture on and off the ball component in the patient's mouth. If necessary, decrease the retention of the liner by inserting the reaming tool from the Cap Attachment Instruments into the liner and turning it clockwise to reduce the retention of the liner's inner walls. When adequate retention has been achieved, process the second liner in the same manner. Insert and adjust only one nylon liner at a time.



Delivering the Final Prosthesis

Insert the finished prosthesis into the patient's mouth and snap the incorporated Cap Attachments onto the Ball Abutments. Make final adjustments to the occlusion. Instruct the patient in the use and care of the prosthesis, and provide oral hygiene instructions. Caution the patient not to use bleach on the prosthesis, which can damage the Cap Attachment Nylon Liners. To prolong the use of the nylon liners, instruct the patient to insert and remove the overdenture by lifting the prosthesis vertically instead of laterally or by twisting. If the Nylon Liners lose retention, they can be easily replaced at a recall appointment. For patients who require stronger Cap Attachment retention, gray Nylon Liners [CAN-G] with more retention are also available.

Non-Engaging Abutment System

Restorative Options with Non-Engaging Components

Non-Engaging Abutments* are used to fabricate implant-level, custom restorations that provide reduced height for vertical occlusal clearance and/or implant angles. These abutment assemblies consist of:

1) A non-engaging gold base, an abutment screw and typically a castable press-fit Plastic Sheath. The press-fit Plastic Sheath is modified and incorporated into the wax framework pattern. After investing, the wax and Plastic Sheath are burned out of the pattern following the lost wax process. When molten alloy is cast into the investment mold, the base component is incorporated into the casting and provides a machined interface that mates directly with the implant.

The gold base is fabricated from a non-oxidizing alloy that promotes chemical adhesion of the cast alloy, but does not permit the adhesion of porcelain. Therefore, a porcelain bonding alloy must be added to all areas of the gold base where porcelain veneering is desired.

2) A non-engaging plastic castable abutment supplied with an abutment screw incorporates the interface of the above mentioned gold base as well as its press-fit Plastic Sheath all in one piece. The plastic abutment is modified and incorporated into the wax framework pattern. After investing, the wax and plastic abutment are burned out of the pattern following the lost wax process. Molten alloy is cast into the investment mold creating a framework pattern which provides a cast interface that mates directly with the implant.

The finished casting can be used as the sub-structure for:

- A screw-retained partial denture that receives a veneering material of choice.
- An implant level multi-unit bar when vertical occlusal clearance does not allow for vertical stacking of the Tapered Abutment Components.
- An implant level multi-unit bar when bucco-lingual or mesial-distal angulation of implants and prosthesis profile does not allow for vertical stacking of the Tapered Abutment Components.



Screw-retained partial denture

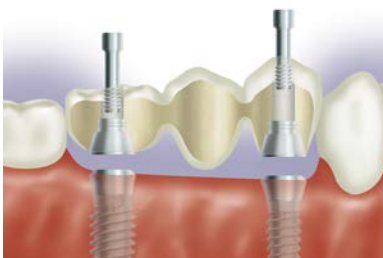

Bar overdenture

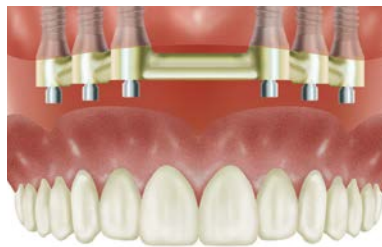

Screw-retained partial denture



Abutments for the Tapered SwissPlus Implant, 4.8 mmD platform



*Components are not available for the Tapered SwissPlus 3.8 mmD platform

Vertical Height Requirements for Non-Engaging Abutments

Non-Engaging Abutments for Tapered SwissPlus implant systems

Non-Engaging Abutment [OPGC and OPCC] for internal octagon Tapered SwissPlus with a 4.8 mmD platform, allows for a low profile connection to the tissue-level implant platform.

The abutment [OPGC] is packaged with a gold base, a 3.8 mmD plastic castable sheath [OPS] and an abutment screw [GPCAS]. The abutment [OPCC] is packaged as plastic castable component with an abutment screw [GPCAS].

Once all the restorative components are in place, the minimum vertical clearance between the implant interface as measured from the height of contour and the opposing dentition is 3.85 mmL (as shown below). The height of the implant interface above the crestal bone is 2.0 mmL with the textured/machined surface junction relative to the crestal bone height.

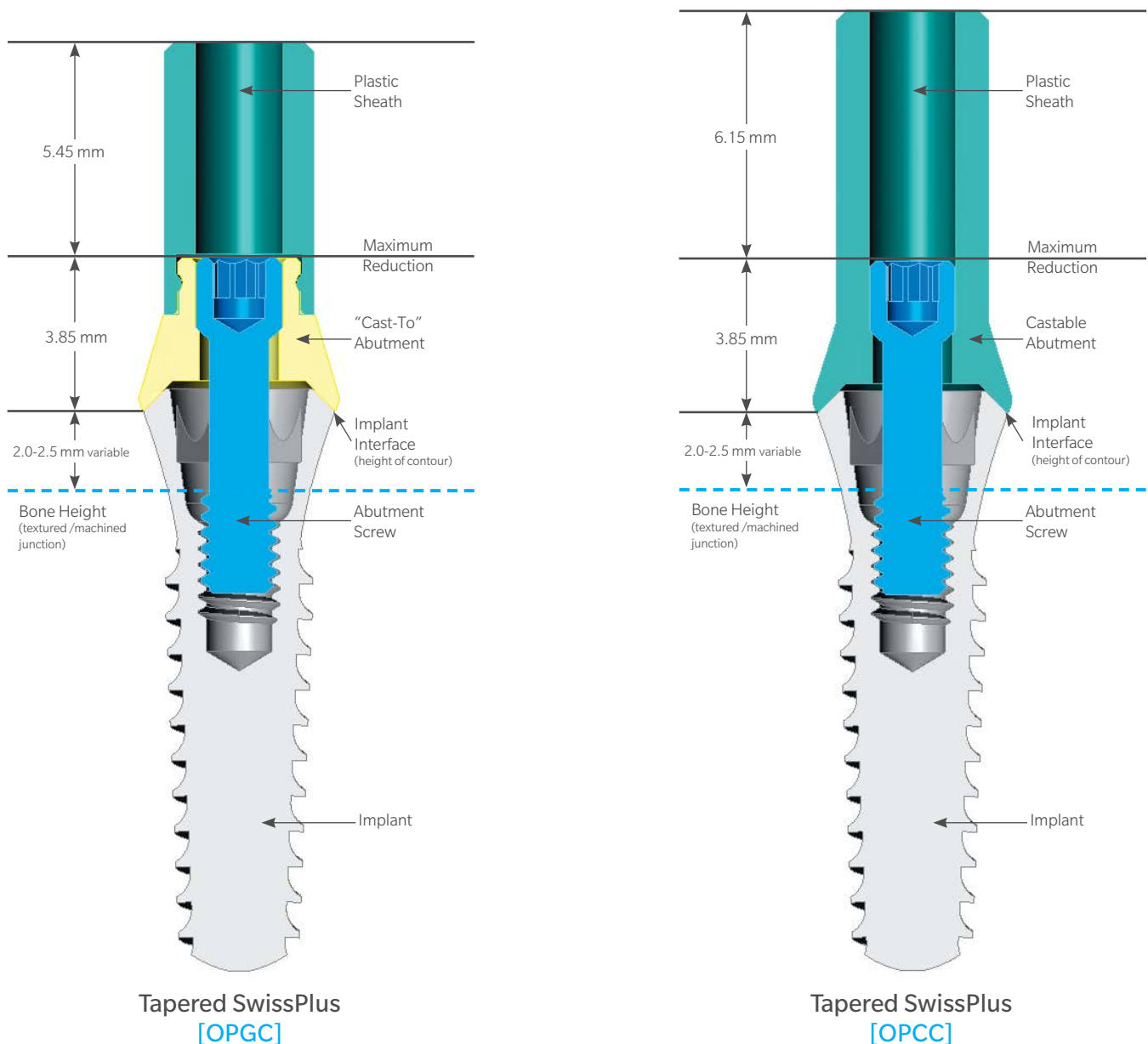

Fabricating Multi-unit Framework Patterns

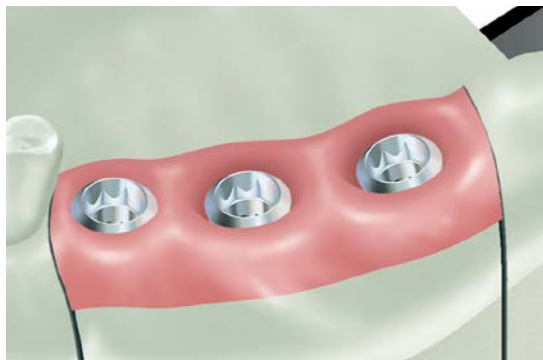

Selecting the Abutment

Fabricate the soft tissue working cast following standard laboratory procedures.

Non-Engaging “Cast-To” Gold Abutments or Plastic Castable Abutments [OPGC and OPCC] respectively are for internal octagon Tapered SwissPlus implants.



Attaching the Abutments and Plastic Sheaths

These abutments are selected in this case due to the limited vertical clearance between the implant platform and the occlusal surface of the opposing dentition. The vertical limitation prevents the use of the Tapered Abutment System.

Carefully seat the assemblies onto the Implant Replicas [OPR] in the working cast. Thread the abutment screws through the abutment assemblies and into the Implant Replicas with the 1.25 mmD Hex Tool. As these components do not engage the internal interface of the implant, finger tightening at this time is sufficient to fully seat the components on the Implant Replicas. Extreme care should be taken with the plastic castable abutment.



Trimming the Plastic Sheaths

Visually determine the modifications needed to provide adequate clearance for adjacent and opposing dentition. Consult with the clinician to determine any additional modifications needed for the case design. Section the plastic sheaths with a cutting disk to obtain the correct vertical and interproximal clearance. Minor circumferential changes can be made to allow the framework to fit within the profile of the desired restoration.



Fabricating the Framework Pattern

Use wax and/or acrylic burnout resin to incorporate the modified abutment into the pattern. Build up the final contours of the pattern with crown-and-bridge wax. If using the gold/plastic combination, carefully apply a thin layer of wax or burnout resin at the junction of the base and the Plastic Sheath to ensure a smooth casting.

An alternative to using the Plastic Sheaths and Abutment Screws:

- Secure the abutments to the Implant Replicas with the Waxing Screws [WSX for internal octagon implants].
- Lightly lubricate the Waxing Screw.
- Use wax and or acrylic burnout resin and fabricate the framework pattern around the screw and directly to the gold base.

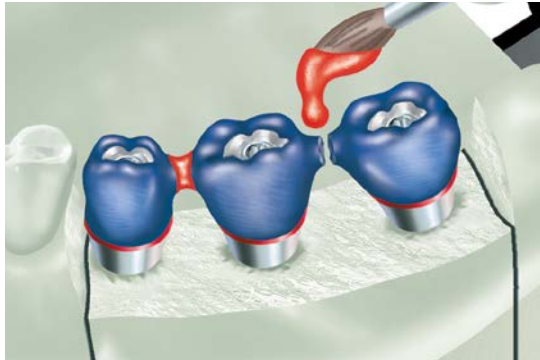

Removing the Framework Pattern

Create a very thin cut between the components to section the framework. Use wax or burnout resin to lute the sections together. This process is incorporated to relieve the stresses in the framework pattern created by contraction distortion of the wax or resin used in the fabrication of the framework pattern.

Remove the abutment screws with the 1.25 mmD Hex Tool then remove the framework pattern from the Implant Replicas [OPR].

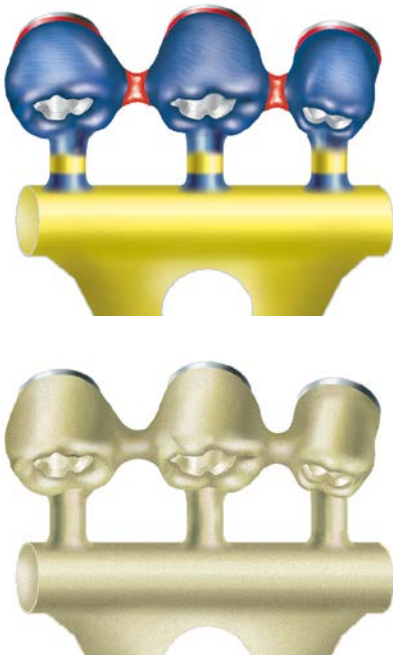

Spruing, Casting and Divesting of the Metal Framework

Attach 10-gauge sprue wax to the thickest part of each unit. Add auxiliary sprues and vents to prevent porosity in the casting, as needed. Connect the framework to a runner bar then assemble to rubber casting base. Do not use a debubbler when investing the gold or plastic components.

When casting to gold components, the casting alloy must not exceed a casting temperature of 2350°F/1288°C. Cast the framework pattern according to conventional techniques utilizing a two-stage burnout, which is standard practice with patterns containing plastic or resin. The burnout temperature should not exceed 1500°F/815°C, with a hold time of no longer than 1 hour. Utilize high noble or noble alloy with a compatible investment material, as described in the manufacturer's guidelines.

Divest the casting; chemical investment removers may also be used with gold components. To ensure that the fitting surface of the incorporated copings are not damaged, protect the abutment interface while blasting the abutment with non-abrasive glass bead. Clean the casting in an ultrasonic unit. Refine the screw access holes within the casting by hand-rotating a reamer for "Cast-To" or Castable Abutments.



Finishing the Metal Framework

Remove the soft tissue replica from the working cast to provide visual access to the cast metal frame/implant replica connection. Confirm a passive fit has been achieved.

Secure the finished framework to the Implant Replicas in the working cast and return it to the clinician for try-in.

Delivering the Final Prosthesis



Removing the Healing Components

Unthread the abutment screws with the 1.25 mmD Hex Tool. Remove the cast framework from the working cast. Sterilize the components according to standard clinical procedures.

Remove the provisional restoration from the patient's mouth. Unthread the Surgical Cover Screws with the 1.25 mmD Hex Tool. Clean and sterilize the components for placement after the cast framework try-in.



Trying in the Metal Framework

To determine a passive fit, the distal unit of the cast metal framework is attached to its corresponding Implant with an abutment screw [GPCAS]. Finger-tighten the screw with the 1.25 mmD Hex Tool. The metal framework is then inspected to verify that no discernable gaps are present between the remaining components and implants. If a gap is present, determine where the framework should be sectioned and follow procedures in Tapered Abutment Section on pages 70 and 71.

Return the framework to the laboratory on the working cast for final processing of the fixed partial denture.



Finishing the Final Prosthesis

Prepare the metal framework to receive the opaque layer according to routine laboratory procedures.

Apply porcelain to the framework and ensure that no porcelain flows inside the screw access channel. Refine the screw access channel within the prosthesis by hand-rotating a reamer for "Cast-To" or Castable Abutments.

Finish the porcelain and polish any metal margins taking care to not alter the area which interfaces with the implant. Seat the finished prosthesis on the working cast and send it to the clinician for final delivery.



Delivering the Final Prosthesis

Remove the provisional restoration and/or healing components from the patient's mouth.

Sterilize and seat the finished prosthesis onto the implants. Thread the abutment screws into the implants with the 1.25 mmD Hex Tool. Torque the screws to 30 Ncm with a calibrated torque wrench.

Confirm the fit, contour and occlusion of the restoration, and make any needed final adjustments. Seal the screw access channels in each abutment with cotton pellets and composite resin material to complete the contour and esthetics of the restoration.

Provide the patient with oral hygiene instructions prior to release.

Accessories

Prosthetic Tools and Torque Wrenches

Hex Tools
1.25 mmD Hex Tools for Abutment
Screws and Fixation Screws



Abutment Removal Tool
for Internal Hex
3.8 mm D Friction-Fit Abutments



Abutment Removal Tool
for Internal Octagon
4.8 mm D Friction-Fit Abutments



Torque Wrenches



Prosthetic Kit Tray - 2320



Cap Attachment Instruments - CAI

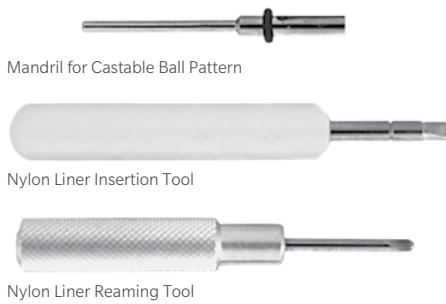

Cap Attachment System - CAS





www.implacom.nl | +31 (0)577 46 1927



Contact us at 1-800-342-5454 or visit

zimmerbiometdental.com

Zimmer Biomet Dental
Global Headquarters
4555 Riverside Drive
Palm Beach Gardens, FL 33410
Tel: +1-561-776-6700
Fax: +1-561-776-1272

Unless otherwise indicated, as referenced herein, all trademarks are the property of Zimmer Biomet; and all products are manufactured by one or more of the dental subsidiaries of Zimmer Biomet Holdings, Inc. and marketed and distributed by Zimmer Biomet Dental and its authorized marketing partners. For additional product information, please refer to the individual product labeling or instructions for use. Product clearance and availability may be limited to certain countries/regions. This material is intended for clinicians only and does not comprise medical advice or recommendations. Distribution to any other recipient is prohibited. This material may not be copied or reprinted without the express written consent of Zimmer Biomet Dental. ZBINST0051 REV B 12/20 ©2020 Zimmer Biomet. All rights reserved.

